



SAS Publishing



SAS/OR[®] 9.1 User's Guide: Bills of Material Processing

The correct bibliographic citation for this manual is as follows: SAS Institute Inc. 2004. *SAS/OR® 9.1 User's Guide: Bills of Material Processing*. Cary, NC: SAS Institute Inc.

SAS/OR® 9.1 User's Guide: Bills of Material Processing

Copyright © 2004, SAS Institute Inc., Cary, NC, USA

ISBN 1-59047-238-1

All rights reserved. Produced in the United States of America. No part of this publication may be reproduced, stored in a retrieval system, or transmitted, in any form or by any means, electronic, mechanical, photocopying, or otherwise, without the prior written permission of the publisher, SAS Institute Inc.

U.S. Government Restricted Rights Notice: Use, duplication, or disclosure of this software and related documentation by the U.S. government is subject to the Agreement with SAS Institute and the restrictions set forth in FAR 52.227-19, Commercial Computer Software-Restricted Rights (June 1987).

SAS Institute Inc., SAS Campus Drive, Cary, North Carolina 27513.

1st printing, January 2004

SAS Publishing provides a complete selection of books and electronic products to help customers use SAS software to its fullest potential. For more information about our e-books, e-learning products, CDs, and hard-copy books, visit the SAS Publishing Web site at support.sas.com/pubs or call 1-800-727-3228.

SAS® and all other SAS Institute Inc. product or service names are registered trademarks or trademarks of SAS Institute Inc. in the USA and other countries. ® indicates USA registration.

Other brand and product names are trademarks of their respective companies.

Contents

What's New in SAS/OR 9 and 9.1	1
Using This Book	7
Chapter 1. The BOM Procedure	15
Chapter 2. Bill-of-Material Post-Processing Macros	85
Appendix A. BOM Web Example	133
Subject Index	153
Syntax Index	157

Acknowledgments

Credits

Documentation

Writing	Tien-yi D. Shaw, Michelle Opp
Editing	Virginia Clark
Documentation Support	Tim Arnold, Michelle Opp
Technical Review	Marc-david Cohen, Phil Gibbs, Tao Huang, Edward P. Hughes, Charles B. Kelly, Michelle Opp, Bengt Pederson

Software

The SAS/OR Bills of Material software was implemented by the Operations Research and Development Department. Substantial support was given to the project by other members of the Analytical Solutions Division. Core Development Division, Display Products Division, Graphics Division, and the Host Systems Division also contributed to this product.

In the following list, the name of the developer currently supporting the component is listed first. Other developers previously worked on the procedure.

PROC BOM	Tien-yi D. Shaw
BOM Macros	Tien-yi D. Shaw
BOM Web Examples	Yi Liao, Tien-yi D. Shaw

Support Groups

Software Testing	Tao Huang, Bengt Pederson
Technical Support	Tonya Chapman

Acknowledgments

Many people have been instrumental in the development of SAS/OR Bills of Material software. We would like to acknowledge Dave Jennings of Lockheed Martin, who has been especially helpful.

The final responsibility for the SAS System lies with SAS Institute alone. We hope that you will always let us know your opinions about the SAS System and its documentation. It is through your participation that SAS software is continuously improved.

What's New in SAS/OR 9 and 9.1

Contents

OVERVIEW	3
THE BOM PROCEDURE	3
THE CLP PROCEDURE (EXPERIMENTAL)	4
THE CPM PROCEDURE	4
THE GA PROCEDURE (EXPERIMENTAL)	4
THE GANTT PROCEDURE	5
THE LP PROCEDURE	5
THE PM PROCEDURE	5
THE QP PROCEDURE (EXPERIMENTAL)	5
BILL OF MATERIAL POST PROCESSING MACROS	5

What's New in SAS/OR 9 and 9.1

Overview

SAS/OR software contains several new and enhanced features since SAS 8.2. Brief descriptions of the new features appear in the following sections. For more information, refer to the SAS/OR documentation, which is now available in the following six volumes:

- SAS/OR User's Guide: Bills of Material Processing
- SAS/OR User's Guide: Constraint Programming
- SAS/OR User's Guide: Local Search Optimization
- SAS/OR User's Guide: Mathematical Programming
- SAS/OR User's Guide: Project Management
- SAS/OR User's Guide: The QSIM Application

The online help can also be found under the corresponding classification.

The BOM Procedure

The BOM procedure in *SAS/OR User's Guide: Bills of Material Processing* was introduced in Version 8.2 of the SAS System to perform bill of material processing. Several new features have been added to the procedure, enabling it to read all product structure records from a product structure data file and all part "master" records from a part master file, and compose the combined information into indented bills of material. This data structure mirrors the most common method for storing bill-of-material data in enterprise settings; the part master file contains data on each part while the product structure file holds data describing the various part-component relationships represented in bills of material.

The PMDATA= option on the PROC BOM statement enables you to specify the name of the Part Master data set. If you do not specify this option, PROC BOM uses the Product Structure data set (as specified in the DATA= option) as the Part Master data set. The BOM procedure now looks up the Part, LeadTime, Requirement, QtyOnHand, and ID variables in the Part Master data set. On the other hand, the Component and Quantity variables remain in the Product Structure data set.

You can use the NRELATIONSHIPS= (or NRELTS=) option to specify the number of parent-component relationships in the Product Structure data set. You have greater control over the handling of redundant relationships in the Product Structure data set using the DUPLICATE= option.

Several options have been added to the STRUCTURE statement enabling you to specify information related to the parent-component relationships. In particular, the variable specified with the PARENT= option identifies the parent item, while the variables listed in the LTOFFSET= option specify lead-time offset information. You can also specify variables identifying scrap factor information for all parent-component relationships using the SFACTOR= option. The RID= option identifies all variables in the Product Structure data set that are to be included in the Indented BOM output data set.

The CLP Procedure (Experimental)

9.1

The new CLP procedure in *SAS/OR User's Guide: Constraint Programming* is an experimental finite domain constraint programming solver for solving constraint satisfaction problems (CSPs) with linear, logical, global, and scheduling constraints. In addition to having an expressive syntax for representing CSPs, the solver features powerful built-in consistency routines and constraint propagation algorithms, a choice of nondeterministic search strategies, and controls for guiding the search mechanism that enable you to solve a diverse array of combinatorial problems.

The CPM Procedure

The CPM procedure in *SAS/OR User's Guide: Project Management* adds more options for describing resource consumption by activities, enhancing its applicability to production scheduling models.

A new keyword, RESUSAGE, has been added to the list of values for the OBSTYPE variable in the Resource data set. This keyword enables you to specify whether a resource is consumed at the beginning or at the end of a given activity.

The MILESTONERESOURCE option enables you to specify a nonzero usage of consumable resources for milestone activities. For example, this option is useful if you wish to designate specific milestones to be the points of payment for a subcontractor. The MILESTONENORESOURCE option is the current default behavior of the CPM procedure, which indicates that all resource requirements are to be ignored for milestone activities.

The GA Procedure (Experimental)

9.1

The new GA procedure in *SAS/OR User's Guide: Local Search Optimization* facilitates the application of genetic algorithms to general optimization. Genetic algorithms adapt the biological processes of natural selection and evolution to search for optimal solutions. The procedure can be applied to optimize problems involving integer, continuous, binary, or combinatorial variables. The GA procedure is especially useful for finding optima for problems where the objective function may have discontinuities or may not otherwise be suitable for optimization by traditional calculus-based methods.

The GANTT Procedure

The GANTT procedure in *SAS/OR User's Guide: Project Management* includes a new option for controlling the width of the Gantt chart. The CHARTWIDTH= option specifies the width of the axis area as a percentage of the total Gantt chart width. This option enables you to generate Gantt charts that are consistent in appearance, independent of the total time spanned by the project.

The LP Procedure

The performances of primal and dual simplex algorithms in the LP procedure (*SAS/OR User's Guide: Mathematical Programming*) have been significantly improved on large scale linear or mixed integer programming problems.

The PM Procedure

The new options added to the CPM procedure are also available with PROC PM.

The QP Procedure (Experimental)

The new QP procedure in *SAS/OR User's Guide: Mathematical Programming* implements a primal-dual predictor-corrector interior-point algorithm for large sparse quadratic programs. Depending on the distribution of the eigenvalues of the Hessian matrix, H , two main classes of quadratic programs are distinguished (assuming minimization):

9.1

- convex: H is positive semi-definite
- nonconvex: H has at least one negative eigenvalue

Diagonal and nonseparable Hessian matrices are recognized and handled automatically.

Bill of Material Post Processing Macros

Several macros enable users to generate miscellaneous reports using the Indented BOM output data set from the BOM procedure in *SAS/OR User's Guide: Bills of Material Processing*. Other transactional macros perform specialized transactions for maintaining and updating the bills of material for a product, product line, plant, or company.

Using This Book

Contents

PURPOSE	9
ORGANIZATION	9
TYPOGRAPHICAL CONVENTIONS	10
CONVENTIONS FOR EXAMPLES	11
ACCESSING THE SAS/OR SAMPLE LIBRARY	12
ONLINE HELP SYSTEM AND UPDATES	13
ADDITIONAL DOCUMENTATION FOR SAS/OR SOFTWARE	13

Using This Book

Purpose

SAS/OR User's Guide: Bills of Material Processing provides a complete reference for the bills of material processing tools in SAS/OR software. This book serves as the primary documentation for the BOM procedure and the bill-of-material post-processing macros. [Chapter 1](#) describes the BOM procedure, and [Chapter 2](#) describes the bill-of-material post-processing macros.

“Using This Book” describes the organization of this book and the conventions used in the text and example code. To gain full benefit from using this book, you should familiarize yourself with the information presented in this section and refer to it when needed. “Additional Documentation” at the end of this section provides references to other books that contain information on related topics.

Organization

[Chapter 1](#) describes the BOM procedure. [Chapter 2](#) and the [Appendix](#) describe the Bill-of-Material Post-Processing Macros and a BOM Web example, respectively. Each chapter description is self-contained; you need to be familiar with only the basic features of the SAS System and SAS terminology to use most of them.

The following list summarizes the types of information provided for the BOM procedure:

Overview provides a general description of what the procedure does. It outlines major capabilities of the procedure and lists all input and output data sets that are used with it.

Getting Started illustrates simple uses of the procedure using a few short examples. It provides introductory *hands-on* information for the procedure.

- Syntax** constitutes the major reference section for the syntax of the procedure. First, the statement syntax is summarized. Next, a functional summary table lists all the statements and options in the procedure, classified by function. In addition, the online version includes a Dictionary of Options, which provides an alphabetical list of all options in the BOM procedure. The PROC BOM statement is then described, followed by a description of the STRUCTURE statement.
- Details** describes the features of the procedure, including algorithmic details and computational methods. It also explains how the various options interact with each other. This section describes input and output data sets in greater detail, with definitions of the output variables, and explains the format of printed output, if any.
- Examples** consists of examples designed to illustrate the use of the procedure. Each example includes a description of the problem and lists the options highlighted by the example. The example shows the data and the SAS statements needed, and includes the output produced. You can duplicate the examples by copying the statements and data and running the SAS program. The SAS Sample Library contains the code used to run the examples shown in this book; consult your SAS Software representative for specific information about the Sample Library. A cross-reference table at the end of the “Examples” section lists all the options illustrated by the different examples in the chapter.
- References** lists references that are relevant to the chapter.

Typographical Conventions

The printed version of *SAS/OR User's Guide: Bills of Material Processing* uses various type styles, as explained by the following list:

roman is the standard type style used for most text.

UPPERCASE ROMAN	is used for SAS statements, options, and other SAS language elements when they appear in the text. However, you can enter these elements in your own SAS code in lowercase, uppercase, or a mixture of the two. This style is also used for identifying arguments and values (in the Syntax specifications) that are literals (for example, to denote valid keywords for a specific option).
UPPERCASE BOLD	is used in the “Syntax” section to identify SAS keywords such as the names of procedures, statements, and options.
bold	is used in the “Syntax” section to identify options.
helvetica	is used for the names of SAS variables and data sets when they appear in the text.
<i>oblique</i>	is used for user-supplied values for options (for example, DUPLICATE= <i>dup</i>).
<i>italic</i>	is used for terms that are defined in the text, for emphasis, and for references to publications.
monospace	is used to show examples of SAS statements. In most cases, this book uses lowercase type for SAS code. You can enter your own SAS code in lowercase, uppercase, or a mixture of the two. This style is also used for values of character variables when they appear in the text.

Conventions for Examples

Most of the output shown in this book is produced with the following SAS System options:

```
options linesize=80 pagesize=60 nonumber nodate;
```

In addition, the graphics output shown in [Chapter 1](#) is produced with the following options:

Printed Version

```
goptions hpos=80 vpos=32;
```

Online Version

```
goptions hpos=80 vpos=32 ypixels=800;
```

The remaining graphics options used in this book depend on the example that creates the output. The general options for the graphics output of [Example 1.1](#) are as follows:

```
goptions hsize=5.75 in vsize=4.0 in;
```

In addition, the following GOPTIONS and PATTERN statements are used to create the online (color) output for this example:

```
goptions cback=ligr;  
pattern1 v=s c=blue;  
pattern2 v=e c=red;  
pattern3 v=e c=magenta;  
pattern4 v=e c=blue;  
pattern5 v=e c=cyan;
```

The following PATTERN statement is used to create the black-and-white output, which appears in the printed version of the manual.

```
pattern1 c=gray v=s r=5;
```

The general options for the graphics output of [Example 1.2](#) are as follows:

```
goptions hsize=5.75 in vsize=8.0 in;
```

In addition, the following GOPTIONS and PATTERN statements are used to create the online (color) output for this example:

```
goptions cback=ligr;  
pattern1 v=e c=blue;  
pattern2 v=e c=red;  
pattern3 v=e c=magenta;  
pattern4 v=e c=blue;  
pattern5 v=e c=cyan;
```

The following PATTERN statement is used to create the black-and-white output, which appears in the printed version of the manual.

```
pattern1 c=black v=e r=5;
```

Accessing the SAS/OR Sample Library

The SAS/OR sample library includes many examples that illustrate the use of SAS/OR software, including the examples used in this documentation. To access these sample programs, select **Learning to Use SAS->Sample SAS Programs** from the **SAS Help and Documentation** window, and then select **SAS/OR** from the list of available topics.

Online Help System and Updates

You can access online help information about SAS/OR software in two ways, depending on whether you are using the SAS windowing environment in the command line mode or the pull-down menu mode.

If you are using a command line, you can access the SAS/OR help menus by typing **help or** on the command line. If you are using the pull-down menus, you can select **SAS Help and Documentation->SAS Products** from the **Help** pull-down menu, and then select **SAS/OR** from the list of available topics.

Additional Documentation for SAS/OR Software

In addition to *SAS/OR User's Guide: Bills of Material Processing*, you may find these other documents helpful when using SAS/OR software:

SAS/OR User's Guide: Constraint Programming

provides documentation for the constraint programming procedure in SAS/OR software. This book serves as the primary documentation for the CLP procedure, an experimental procedure new to SAS/OR software.

SAS/OR User's Guide: Local Search Optimization

provides documentation for the local search optimization procedure in SAS/OR software. This book serves as the primary documentation for the GA procedure, an experimental procedure that uses genetic algorithms to solve optimization problems.

SAS/OR User's Guide: Mathematical Programming

provides documentation for the mathematical programming procedures in SAS/OR software. This book serves as the primary documentation for optimization procedures, such as the ASSIGN, LP, INTPOINT, NETFLOW, NLP, and TRANS procedures, and the new procedure, QP, for solving quadratic programming problems.

SAS/OR User's Guide: Project Management

provides documentation for the project management procedures in SAS/OR software. This book serves as the primary documentation for the CPM, DTREE, GANTT, NETDRAW, and PM procedures, as well as the PROJMAN Application, a graphical user interface for project management.

SAS/OR User's Guide: The QSIM Application

provides documentation for the QSIM Application, which is used to build and analyze models of queueing systems using discrete event simulation. This book shows you how to build models using the simple point-and-click graphical user interface, how to run the models, and how to collect and analyze the sample data to give you insight into the behavior of the system.

SAS/OR Software: Project Management Examples, Version 6

contains a series of examples that illustrate how to use SAS/OR software to manage projects. Each chapter contains a complete project management scenario and describes how to use PROC GANTT, PROC CPM, and PROC NETDRAW, in addi-

tion to other reporting and graphing procedures in the SAS System, to perform the necessary project management tasks.

SAS/IRP User's Guide: Inventory Replenishment Planning

provides documentation for SAS/IRP software. This book serves as the primary documentation for the IRP procedure for determining replenishment policies, as well as the %IRPSIM SAS programming macro for simulating replenishment policies.

Chapter 1

The BOM Procedure

Chapter Contents

OVERVIEW	17
GETTING STARTED	18
SYNTAX	24
Functional Summary	24
PROC BOM Statement	25
STRUCTURE Statement	26
DETAILS	30
Part Master Data Set	30
Product Structure Data Set	32
Indented BOM Data Set	34
Bill of Material Explosion and Implosion	38
Summarized Parts Data Set	40
Missing Values in the Input Data Sets	42
Macro Variable <code>_ORBOM_</code>	43
Computer Resource Requirements	44
EXAMPLES	44
Example 1.1. Bill of Material with Single Input Data Set	44
Example 1.2. Bill of Material with Lead Time Information	48
Example 1.3. Bill of Material with Scrap Factor Information	54
Example 1.4. Planning Bill of Material	57
Example 1.5. Modular Bills of Material	63
Example 1.6. Bills of Material with Repeated Relationships	66
Example 1.7. Bills of Material Verification	70
Example 1.8. Roll-Up Cost in Indented Bill of Material	73
Example 1.9. Bill of Material Explosion	76
Example 1.10. Aggregating Forecasts Using PROC BOM	79
Statement and Option Cross-Reference Tables	83
REFERENCES	84

Chapter 1

The BOM Procedure

Overview

The BOM procedure performs bill-of-material processing. It reads all product structure records from a product structure data file and all part “master” records from a part master file, and composes the combined information into indented bills of material. In addition, PROC BOM can also output a summarized parts list, which lists all items and their total quantities required (needed to be made or ordered) in order to fill a given production plan. A *production plan* is an agreed-upon plan that comes from the aggregate planning function; specifically, it is the overall level of manufacturing output planned to be produced for each product family in each planning period (Cox and Blackstone 1998). Production plan information can be included in the part master file.

According to Cox and Blackstone (1998), a *product structure record* defines the relationship of one component to its immediate parent. It also contains fields for quantity required, scrap factor, lead-time offset, engineering effectivity, and so on. A *part master record* typically contains identifying and descriptive data such as part number and part description, and control values (for instance, lead time, lot size, cost, etc.). It may contain “dynamic” data such as inventory status (for instance, quantities on hand) and production plan data (for instance, requirements, due dates, etc.). Part master records are linked by product structure records or bill of material records, thus defining the bill of material.

Also based on Cox and Blackstone (1998), a *bill of material* (BOM) for an item is a list of all items, ingredients, or materials needed to make one production run of the given item. The bill of material may also be called the *formula*, *recipe*, or *ingredients list* in certain process industries. The way in which the bill of material data are organized and presented is called the *structure* of the bill of material or the structure of the product.

A variety of display formats is available for bills of material. The simplest format is the *single-level bill of material*. It consists of a list of all components that are directly used in a parent item. It shows only the relationships one level down. On the other hand, a *multilevel bill of material* provides a display of all components that are directly or indirectly used in a parent item. When an item is a subcomponent, blend, intermediate, etc., then all of its components are also exhibited, down to purchased parts and raw materials.

An *indented bill of material* is one form of a multilevel BOM. It exhibits the highest level parent item as level 0, and all components going into this parent item are indented as level 1. All subsequent components are indented one level below their parent items; that is, the level number is increased by 1. If an item is used in more than one parent within a given product structure, it appears more than once, under

every subassembly in which it is used. You can view an indented bill of material as a *family tree* with multiple levels. The *summarized bill of material* is another form of a multilevel bill of material. It lists all the items and their quantities that are used in a given product structure. Unlike the indented bill of material, it does not list the level numbers of items and does not illustrate the parent-component relationships. Moreover, the summarized bill of material lists each item only once for the total quantity required. Refer to Cox and Blackstone (1998) for further details.

The input data sets used by the procedure are the **Product Structure** data set and the **Part Master** data set. The **Product Structure** data set contains all product structure records, and the **Part Master** data set contains all part master records for a product, product line, plant, or company. You can combine the product structure data and the part master data into one input data set and assign it as the **Product Structure** data set; the BOM procedure assumes that all the part master information is also available in this combined data set.

The **Indented BOM** output data set produced by PROC BOM contains all indented bills of material for the product, product line, plant, or company. This data set is organized in such a manner that it can be easily retrieved and manipulated to generate reports, and can also be used by other SAS/OR procedures to perform additional analysis. See [Example 1.1](#) on page 44 and [Example 1.2](#) on page 48 as examples of using the NETDRAW procedure to draw a tree diagram for an indented bill of material. [Chapter 2, “Bill-of-Material Post-Processing Macros,”](#) describes a collection of SAS macros that use the Indented BOM data set as input data to create reports or perform specialized transactions for maintaining the bills of material.

The BOM procedure can optionally produce a **Summarized Parts** output data set. This output data set lists all items and their quantities required (needed to be made or ordered) to fill the production plan specified in the part master file. This list is useful in gross requirements planning and other applications.

Getting Started

The ABC Lamp Company product line example from Fogarty, Blackstone, and Hoffmann (1991) illustrates the basic features of PROC BOM. The Part Master data set, **PMaster0**, displayed in [Figure 1.1](#), contains the part master records for all items in the company. Each master record contains the part number (denoted by the **Part** variable) and the part description (denoted by the **Desc** variable) for an item. It also contains data on unit of measure (denoted by the **Unit** variable) for the item. The Product Structure data set, **ParComp0**, displayed in [Figure 1.2](#), contains all product structure records in the company. Each product structure defines a parent-component relationship. The **Parent** variable contains the part number for the parent item and the **Component** variable contains the part number for the component. The **QtyPer** variable contains the quantity per assembly for the parent-component relationship.

The values for the **Parent** and **Component** variables are linked by the value of the **Part** variable in the Part Master data set to define the parent-component relationship. For example, in the 11th observation of the data set **ParComp0** (as displayed in [Figure 1.2](#)), the value `'1100'` for the **Parent** variable is linked to the first observa-

tion of the data set PMaster0 (as displayed in Figure 1.1), which provides the part description and unit of measure for the parent item. Similarly, the value of '2100' for the Component variable is linked to the eighth observation of the part master file providing the master data for the component. Therefore, the parent-component relationship that is represented in the 11th observation of the product structure data set, ParComp0, should be interpreted as: each finished shaft uses 26 inches of 3/8 steel tubing.

ABC Lamp Company				
Part Master Data Set				
Obs	Part	Desc		Unit
1	1100	Finished shaft		Each
2	1200	6-Diameter steel plate		Each
3	1300	Hub		Each
4	1400	1/4-20 Screw		Each
5	1500	Steel holder		Each
6	1600	One-way socket		Each
7	1700	Wiring assembly		Each
8	2100	3/8 Steel tubing		Inches
9	2200	16-Gauge lamp cord		Feet
10	2300	Standard plug terminal		Each
11	A100	Socket assembly		Each
12	B100	Base assembly		Each
13	LA01	Lamp LA		Each
14	S100	Black shade		Each

Figure 1.1. Part Master File (PMaster0)

ABC Lamp Company				
Product Structure Data Set				
Obs	Parent	Component		Qty Per
1	LA01	B100		1
2	LA01	S100		1
3	LA01	A100		1
4	B100	1100		1
5	B100	1200		1
6	B100	1300		1
7	B100	1400		4
8	A100	1500		1
9	A100	1600		1
10	A100	1700		1
11	1100	2100		26
12	1500	1400		2
13	1700	2200		12
14	1700	2300		1

Figure 1.2. Product Structure File (ParComp0)

The following code invokes PROC BOM to produce the indented bill of material for the product 'LA01' and the summarized parts list for the production plan in which 1 unit of 'LA01' is planned in the current planning period (period 1).

```

/* Create the indented BOM and summarized parts list */
proc bom data=ParComp0 pmdata=PMaster0
  out=IndBOM0 summaryout=SumBOM0;
  structure / part=Part
             parent=Parent
             component=Component
             quantity=QtyPer
             id=(Desc Unit);
run;

```

The Indented BOM data set, IndBOM0, is displayed in Figure 1.3. This data set contains the indented bill of material for the product 'LA01'. Each record or observation in this data set contains product structure data: the part number for the parent item is contained in the `_Parent_` variable, the part number for the component is contained in the `_Part_` variable, and the quantity per assembly is contained in the `QtyPer` variable. It also contains the part master data (`Desc` and `Unit` variables) from the Part Master data set for the component identified by the `_Part_` variable. If a component is used in more than one parent item, it appears in multiple records. For example, the item 1/4-20 Screw (part number '1400') is used in both Base assembly (part number 'B100') and Steel holder (part number '1500'); this item occurs in records identified by the values 6 and 10 for the variable `Part_ID`.

ABC Lamp Company									
Indented Bill of Material, Part LA01									
—	—			Q		P			
L	P			t		a	P		
e	a			Y		r	a	—	
v	r	P	D	—		e	r	P	
e	r	e		P	U	n	t	r	
l	t	s		P	n	—	—	o	
—	—	c		r	i	I	I	d	
				d	t	D	D	—	
0		LA01	Lamp LA	.	1	Each	.	0	LA01
1	LA01	B100	Base assembly	1	1	Each	0	1	LA01
2	B100	1100	Finished shaft	1	1	Each	1	2	LA01
3	1100	2100	3/8 Steel tubing	26	26	Inches	2	3	LA01
2	B100	1200	6-Diameter steel plate	1	1	Each	1	4	LA01
2	B100	1300	Hub	1	1	Each	1	5	LA01
2	B100	1400	1/4-20 Screw	4	4	Each	1	6	LA01
1	LA01	S100	Black shade	1	1	Each	0	7	LA01
1	LA01	A100	Socket assembly	1	1	Each	0	8	LA01
2	A100	1500	Steel holder	1	1	Each	8	9	LA01
3	1500	1400	1/4-20 Screw	2	2	Each	9	10	LA01
2	A100	1600	One-way socket	1	1	Each	8	11	LA01
2	A100	1700	Wiring assembly	1	1	Each	8	12	LA01
3	1700	2200	16-Gauge lamp cord	12	12	Feet	12	13	LA01
3	1700	2300	Standard plug terminal	1	1	Each	12	14	LA01

Figure 1.3. Indented Bill of Material (IndBOM0)

As discussed in the “Overview” section beginning on page 17, each indented bill of material can be illustrated by a family tree. In fact, each record in the Indented BOM data set corresponds to a node in this tree. Figure 1.4 displays the tree diagram for the indented bill of material in the IndBOM0 data set. Each tree node or record is uniquely identified by a *sequence* or *ID* number that is assigned to it by the procedure. The *Part_ID* variable contains this ID number for each record. The *Parent_ID* variable contains the sequence number for the parent node or parent record. A *parent record* for a given record is the record that defines the parent node of the node defined by the given record. For example, the parent record of record 6 in the data set IndBOM0 is record 1, while record 9 is the parent record of record 10. Record 0 has no parent record.

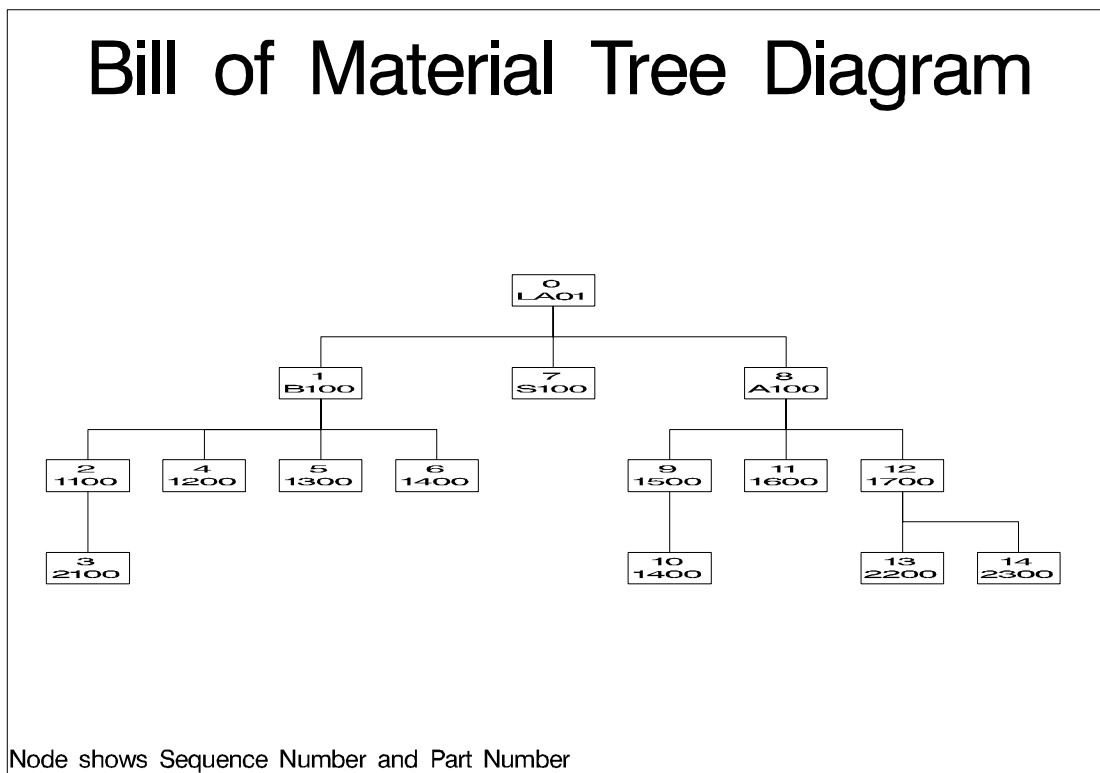

Figure 1.4. Tree Diagram for the Bill of Material for LA01

The IndBOM0 data set contains other data: The *_Level_* variable denotes the indented level number for each node or record. The root node with the sequence number 0 is at level 0, and the level numbers increase as you look down the tree. The *_Prod_* variable contains the part number of the end item. The *Qty_Prod* variable contains the *quantity per product*, that is, the quantity of the component identified by the *_Part_* variable required to make one unit of the end item ‘LA01’. Note that in this particular example, the values of the *Qty_Prod* variable are identical to the values of the *QtyPer* variable. This is because the quantities per assembly for all the parent-component relationships are 1, except for relationships ‘B100’-‘1400’, ‘1100’-‘2100’, ‘1500’-‘1400’, ‘1700’-‘2200’. The components (‘1400’, ‘2100’, and ‘2200’) of these parent-component relationships do not have any subcomponents themselves.

Figure 1.3, as well as Figure 1.4, shows that the Indented BOM data set lists all the records in *depth-first* order. This scheme lists tree nodes from top to bottom and from left to right. For example, item '1100' is listed directly after its parent, 'B100', and before items 'S100' and 'A100' (the right siblings of item 'B100'). Similarly, item '2100' is listed directly after item '1100' and before items '1200', '1300', and '1400'. Refer to Aho, Hopcroft, and Ullman (1983) for details on depth-first ordering. See also the “Indented BOM Data Set” section beginning on page 34 for details regarding the records in this data set.

ABC Lamp Company							
Summarized Parts List, Period 1							
<u>Part</u>	<u>Low_Code</u>	<u>Gros_Req</u>	<u>On_Hand</u>	<u>Net_Req</u>	<u>Desc</u>	<u>Unit</u>	
1100	2	1	0	1	Finished shaft	Each	
1200	2	1	0	1	6-Diameter steel plate	Each	
1300	2	1	0	1	Hub	Each	
1400	3	6	0	6	1/4-20 Screw	Each	
1500	2	1	0	1	Steel holder	Each	
1600	2	1	0	1	One-way socket	Each	
1700	2	1	0	1	Wiring assembly	Each	
2100	3	26	0	26	3/8 Steel tubing	Inches	
2200	3	12	0	12	16-Gauge lamp cord	Feet	
2300	3	1	0	1	Standard plug terminal	Each	
A100	1	1	0	1	Socket assembly	Each	
B100	1	1	0	1	Base assembly	Each	
LA01	0	1	0	1	Lamp LA	Each	
S100	1	1	0	1	Black shade	Each	

Figure 1.5. Summarized Parts List (SumBOM0)

The Summarized Parts data set, SumBOM0, is displayed in Figure 1.5. This data set, which has been sorted by the `_Part_` variable, has a record for each item in the ABC Lamp Company's product line. Each record contains the part master data from the Part Master data set, PMaster0. The `_Part_`, `Desc`, and `Unit` variables contain the part number, part description, and unit of measure, respectively, for each item. It also contains some other data: The `Low_Code` variable denotes the *low-level code* of the item. The low-level code for an item is a number that indicates the lowest level in any bill of material at which this item appears. For example, item '1400' appears at levels 2 and 3 in this example; thus, its low-level code is 3. The low-level codes are necessary to make sure that the net requirement for a given item is not calculated until all the gross requirements have been calculated down to that level. The `On_Hand` variable contains the quantity of the item currently on hand. Since the part master file (as shown in Figure 1.1) does not contain any quantity on hand information, the procedure assumes that this variable is 0 for all items. The `Gros_Req` and `Net_Req` variables contain the gross and net requirements, respectively. Again, since the PMaster0 data set does not provide any production plan information, PROC BOM assumes that the final product, 'LA01', is the only master schedule item and the gross requirement for this item is 1 unit. The net requirement for item 'LA01' is the gross requirement (1) minus the quantity on hand (0). The gross and net requirements of the other items are then calculated sequentially:

'B100' Base assembly (1 per lamp)

Gross requirement		
(= net requirement of 'LA01' × quantity per assembly)	$1 \times 1 = 1$	
Quantity on hand		<u>-0</u>
Net requirement		1

'1100' Finished shaft (1 per base assembly)

Gross requirement		
(= net requirement of 'B100' × quantity per assembly)	$1 \times 1 = 1$	
Quantity on hand		<u>-0</u>
Net requirement		1

'2100' 3/8 Steel tubing (26 inches per shaft)

Gross requirement		
(= net requirement of '1100' × quantity per assembly)	$1 \times 26 = 26$	
Quantity on hand		<u>-0</u>
Net requirement		26

If an item (such as item '1400' in this example) is used in more than one assembly, the gross requirement is the total needed in all assemblies where it is used. See the “[Summarized Parts Data Set](#)” section beginning on page 40 for details on determining the gross and net requirements.

Recall that the Part Master data set (as shown in [Figure 1.1](#)) does not contain any quantity on hand and requirement information, and item 'LA01' is the only final product. Thus, in this example, the summarized parts list (as displayed in [Figure 1.5](#) on page 22) is actually the same as the summarized bill of material for item 'LA01', with the gross (or net) requirement representing the total usage of each item.

Syntax

The following statements are available in PROC BOM.

PROC BOM *options* ;
STRUCTURE / *options* ;

Functional Summary

The following table outlines the options available for the BOM procedure.

Table 1.1. PROC BOM Options

Task	Statement	Option
Data Set Specification Product Structure input data set Part Master input data set Indented BOM output data set Summarized Parts output data set	PROC BOM PROC BOM PROC BOM PROC BOM	DATA= PMDATA= OUT= SUMMARYOUT=
Part Master Information Specification ID <i>variables</i> lead time <i>variable</i> part <i>variable</i> quantity on hand <i>variable</i> gross requirement <i>variable</i>	STRUCTURE STRUCTURE STRUCTURE STRUCTURE STRUCTURE	ID= LEADTIME= PART= QTYONHAND= REQUIREMENT=
Problem Size Options do not use utility data set number of items number of product structure records	PROC BOM PROC BOM PROC BOM	NOUTIL NPARTS= NRELTS=
Product Structure Specification end items	STRUCTURE	ENDITEM=
Identical Relationships Handling Specification handling of identical product structure records	PROC BOM	DUPLICATE=
Relationship Information Specification component <i>variables</i> scrap factor <i>variables</i> lead-time offset <i>variables</i> parent <i>variable</i> quantity per assembly <i>variables</i> RID <i>variables</i>	STRUCTURE STRUCTURE STRUCTURE STRUCTURE STRUCTURE STRUCTURE	COMPONENT= FACTOR= OFFSET= PARENT= QUANTITY= RID=

PROC BOM Statement

PROC BOM *options* ;

The PROC BOM statement invokes the procedure. You can specify the following options in the PROC BOM statement.

DATA=SAS-data-set

PSDATA=SAS-data-set

names the input SAS data set that contains all the product structure records (parent-component relationship, quantity per assembly, scrap factor, etc.) for a product, product line, plant or company. More than one product structure record can be specified in one observation if they have the same parent item. This data set is also referred to as the Product Structure data set, the Single-level BOM data set, or the Parent-Component Relationship Structure data set. See the “[Product Structure Data Set](#)” section on page 32 for information about the variables that can be included in this data set. If you do not specify the DATA= option, PROC BOM uses the most recently created SAS data set as the input data set.

DUPLICATE=dup

specifies how to handle identical product structure records in the Product Structure data set. Two product structure records are called *identical* if they have exactly the same values for the parent, component, lead-time offset, and all the RID variables. The values allowed for this option are

COMBINE

combines the values of the quantity per assembly and scrap factor of all identical product structure records together. See the “[Product Structure Data Set](#)” section beginning on page 32 for details on how the procedure combines identical product structure records. The default value is *COMBINE*.

DISCARD

discards all identical product structure records except the first one.

KEEP

keeps all identical product structure records.

NOUTIL

specifies that the procedure should not use utility data sets for memory management. By default, the procedure resorts to the use of utility data sets and swaps between core memory and utility data sets as necessary if the number of part master or product structure records in the input data sets is larger than the number of part master or product structure records for which memory is initially allocated in core. Specifying this option causes the procedure to increase the memory allocation; if the problem is too large to fit in core memory, PROC BOM stops with an error message.

NPARTS=nparts

specifies the number of part master records for which memory is initially allocated in core by the procedure. This enables PROC BOM to make better use of available memory. See the “[Computer Resource Requirements](#)” section on page 44 for details. The default value is the number of observations in the [Part Master](#) data set.

NRELTS=*nrelts***NRELATIONSHIPS**=*nrelts*

specifies the number of product structure records for which memory is initially allocated in core by the procedure. This enables PROC BOM to make better use of available memory. See the “[Computer Resource Requirements](#)” section on page 44 for details. The default value is $nobs \times ncomp$, where *nobs* is the number of observations in the [Product Structure](#) data set and *ncomp* is the number of the [Component](#) variables.

OUT=*SAS-data-set***INDBOM**=*SAS-data-set*

specifies a name for the output SAS data set that contains the indented bills of material for all final products in the input data sets or all end items specified in the **ENDITEM=** option. This data set is also referred to as the Indented BOM data set. See the “[Indented BOM Data Set](#)” section on page 34 for information about the variables that are included in this data set. If the **OUT=** option is omitted, the SAS System creates a data set and names it according to the *DATA**n* naming convention.

PMDATA=*SAS-data-set***PMASTER**=*SAS-data-set*

names the input SAS data set that contains all the part (item) master records for a product, product line, plant or company. Each observation in this data set contains one part master record. This data set is also referred to as the Part Master data set. See the “[Part Master Data Set](#)” section on page 30 for information about the variables that can be included in this data set. If you do not specify the **PMDATA=** option, PROC BOM assumes that the part master data are also included in the [Product Structure](#) input data set.

SUMMARYOUT=*SAS-data-set***SUMPART**=*SAS-data-set*

specifies a name for the output SAS data set that contains the summarized parts list for the production plan specified in the [Part Master](#) data set. This data set is also referred to as the Summarized Parts data set. See the “[Summarized Parts Data Set](#)” section on page 40 for information about the variables that are included in this data set. If the **SUMMARYOUT=** option is omitted, PROC BOM does not produce the summarized parts list.

STRUCTURE Statement

STRUCTURE / *options* ;

The **STRUCTURE** statement lists the variables in the [Product Structure](#) and the [Part Master](#) input data sets. The main variable in the [Part Master](#) data set is the [Part](#) variable; the main variables in the [Product Structure](#) data set are the [Parent](#) and [Component](#) variables. If all the part master data are contained in the [Product Structure](#) data set, you need not specify a [Part Master](#) data set.

If two separate input data sets are specified, you must specify both a [Part](#) variable and a [Parent](#) variable. Otherwise, you may specify either a [Parent](#) variable or a [Part](#) variable, or both. You must always specify at least one [Component](#) variable.

The number of **Component** variables specified must be equal to the number of the product structure records (number of relationships specified) in each observation of the **Product Structure** data set. All other variables are optional. However, if you specify the **Quantity**, **Offset**, or **Factor** variables, you must have the same number of these variables as the number of **Component** variables.

In this statement, you can also explicitly specify the items that are to be used as the end (level-0) items.

COMPONENT=(*variables*)

COMP=(*variables*)

specifies variables in the **Product Structure** input data set that contain the part numbers (identifications) of the components that are directly used in the common parent item identified by the **Parent** variable. These variables are also referred to as **Component** variables. The **Component** variables must be of the same type, format, and length as the **Part** variable in the **Part Master** data set. At least one **Component** variable must be specified.

Note: This variable is case-sensitive when it is in character format.

ENDITEM=(*enditems*)

specifies the items that are to be used as the highest level or level-0 items (also referred to as *end items*) in the indented bills of material. In other words, this option can be used to construct indented bills of material and summarized parts list for sub-assemblies. The values for *enditems* must be either numbers (if the **Part** variable is numeric) or quoted strings (if the **Part** variable is character). If you do not specify this option, the procedure assumes every final product (finished good) is an end item and builds an indented bill of material for it.

FACTOR=(*variables*)

SFACTOR=(*variables*)

identifies variables in the **Product Structure** data set that contain the scrap factor information for each product structure record with the parent item identified by the **Parent** variable and the component identified by each of the **Component** variables; the *i*th factor variable corresponds to the *i*th **Component** variable. The *scrap factor* is used to increase the gross requirement to account for anticipated loss within the manufacture of a particular parent item (Cox and Blackstone 1998). These variables are also referred to as the **Factor** variables. The variables specified must be numeric and the number of **Factor** variables must be equal to the number of **Component** variables. If you do not specify this option, PROC BOM assumes the scrap factors for all product structure records to be 0.

ID=(*variables*)

identifies all variables in the **Part Master** data set that are not specified in the **LEADTIME**=, **PART**=, **QTYONHAND**=, or **REQUIREMENT**= options, and are to be included in the **Indented BOM** and the **Summarized Parts** output data sets. These variables are also referred to as ID variables. An ID variable cannot be named as: **Gros_Req**, **_Level_**, **_L_Offset**, **Low_Code**, **Net_Req**, **On_Hand**, **_Parent_**, **Paren_ID**, **_Part_**, **Part_ID**, **_Prod_**, **Qty_Per**, **Qty_Prod**, **S_Factor**, **Tot_Lead**, or **Tot_Off**. This option is useful for carrying any identifying and

descriptive information (part description, unit of measure, etc.) and control values (lot size, unit cost, etc.) about each item (identified by the **Part** variable) from the **Part Master** data set to the output data sets.

LEADTIME=*variable*

DUR=*variable*

identifies the variable in the **Part Master** data set that contains the lead time information for the item identified by the **Part** variable. The *lead time* of an item is the length of time between recognition of the need for an order and the receipt of the goods. Individual components of lead time can include order preparation time, queue time, processing time, move or transportation time, and receiving and inspection time (Cox and Blackstone 1998). This variable is also referred to as the **LeadTime** variable. The variable specified must be numeric. If you do not specify this option, PROC BOM assumes the lead time for each item to be 0. On the other hand, if this option is specified, the procedure creates a new variable, **Tot_Lead**, in the **Indented BOM** data set to contain the total lead time. See the “**Indented BOM Data Set**” section on page 34 for details on the calculation of the total lead time.

OFFSET=(*variables*)

LTOFFSET=(*variables*)

identifies variables in the **Product Structure** data set that contain the lead-time offset information for each product structure record with the parent item identified by the **Parent** variable and the component identified by each of the **Component** variables; the *i*th offset variable corresponds to the *i*th **Component** variable. The *lead-time offset* can be used to control when materials are issued to a work center as well as to determine the need date when planning, purchasing, or manufacturing a particular component (Clement, Coldrick, and Sari 1992). These variables are also referred to as the **Offset** variables. The variables specified must be numeric and the number of **Offset** variables must be equal to the number of **Component** variables. If you do not specify this option, PROC BOM assumes the lead-time offsets for all product structure records to be 0. On the other hand, if this option is specified, the procedure creates a variable, **Tot_Off**, in the **Indented BOM** data set to contain the total offset. See the “**Indented BOM Data Set**” section on page 34 for details on the calculation of the total offset.

Note: The lead-time offset and the total offset can be expressed in units that are different from the lead time.

PARENT=*variable*

specifies the variable in the **Product Structure** data set that contains the part number or identification for the immediate parent item of the components identified by the **Component** variables. This variable is also referred to as the **Parent** variable. The **Parent** variable must be of the same type, format, and length as the **Part** variable in the **Part Master** data set. You must specify this option whenever a **Part Master** data set is explicitly specified in addition to the **Product Structure** data set. On the other hand, if a **Part Master** data set is not specified, the **Parent** variable is not necessary; if this variable is not specified, the procedure assumes that it is the same as the variable specified in the **PART=** option.

Note: This variable is case-sensitive when it is in character format.

PART=*variable*

ITEM=*variable*

specifies the variable in the [Part Master](#) data set that contains the part number or identification. This variable is also referred to as the **Part** variable. The **Part** variable can be either character or numeric. You must specify this option whenever a [Part Master](#) data set is specified in addition to the [Product Structure](#) data set. Otherwise, the **Part** variable is not necessary; if this variable is not specified, the procedure assumes that it is the same as the variable specified in the **PARENT=** option.

Note: This variable is case-sensitive when it is in character format.

QTYONHAND=*variable*

INVENTORY=*variable*

identifies the variable in the [Part Master](#) data set that contains the quantity currently on hand for the item identified by the **Part** variable. This variable is also referred to as the **QtyOnHand** variable. The **QtyOnHand** variable must be numeric. If you do not specify the **QtyOnHand** variable, the procedure assumes that you do not have any items on hand.

QUANTITY=(*variables*)

QTYPER=(*variables*)

identifies variables in the [Product Structure](#) data set that contain the quantity per assembly information for each product structure record with the parent item identified by the **Parent** variable and the components identified by each of the **Component** variables; the *i*th quantity variable corresponds to the *i*th **Component** variable. The *quantity per assembly* for a given parent-component relationship is the quantity of the component to be used in the production of 1 unit of the parent item. These variables are also referred to as the **Quantity** or **QtyPer** variables. The variables specified must be numeric and the number of **Quantity** variables must be equal to the number of **Component** variables. If you do not specify these variables, the procedure assumes that you need 1 unit of each listed component identified by a **Component** variable to make 1 unit of the parent item identified by the **Parent** variable.

REQUIREMENT=*variable*

GROSSREQ=*variable*

identifies the variable in the [Part Master](#) data set that contains the gross requirement (the quantity planned to be produced in a production plan) for the item identified by the **Part** variable. This variable is also referred to as the **Requirement** variable and must be numeric. If you do not specify this option, the procedure assumes that the gross requirements for all items are missing except for the final products or end items. All final products or end items are assumed to have gross requirements of 1 unit. In other words, if the [Part Master](#) data set does not contain the production plan information, PROC BOM uses a default production plan in which each end item has a requirement of 1 unit. The procedure uses the specified (or assumed) values of the **Requirement** variable to calculate the gross requirements for all other items. These values are saved in the **Requirement** variable in the [Summarized Parts](#) output data set if the **SUMMARYOUT=** option is specified. If the **REQUIREMENT=** option is not specified, the [Summarized Parts](#) data set uses the default name, **Gros_Req**. See the “[Summarized Parts Data Set](#)” section beginning on page 40 for details on the

calculation of the gross requirements.

RID=(variables)

identifies all variables in the **Product Structure** data set that are not specified in the **COMPONENT=**, **FACTOR=**, **OFFSET=**, **PARENT=**, or **QUANTITY=** options, and are to be included in the **Indented BOM** data set. These variables are also referred to as RID variables. The RID variables cannot be named as: **_Level_**, **L_Offset**, **_Parent_**, **Parent_ID**, **_Part_**, **Part_ID**, **_Prod_**, **Qty_Per**, **Qty_Prod**, **S_Factor**, **Tot_Lead**, or **Tot_Off**. This option is useful for carrying other information stored in a product structure record to the **Indented BOM** data set. This typically includes *engineering effectivity*, *operation number*, *reference designator*, and *line sequence number*.

The number of RID variables specified must be a multiple of the number of the **Component** variables. If you specify m RID and n **Component** variables as

```
component=(COMP1-COMPn)
RID=(VAR1-VARm)
```

the procedure distributes these m RID variables to each product structure record with the parent item identified by the **Parent** variable and the component identified by each of the **Component** variables in the following manner:

component	1st RID variable	2nd RID variable	...	k th RID variable
COMP ₁	VAR ₁	VAR _{$n+1$}		VAR _{$m-n+1$}
COMP ₂	VAR ₂	VAR _{$n+2$}		VAR _{$m-n+2$}
.....				
COMP _{n}	VAR _{n}	VAR _{$2n$}		VAR _{m}

where $k = m/n$. Note that the procedure treats the variables VAR₁ to VAR _{n} as the first RID variable for each of the n product structure records, and hence, they must have the same type, format, and length. The same rules apply to variables VAR _{$n+1$} to VAR _{$2n$} , ..., VAR _{$m-n+1$} to VAR _{m} , etc.

Details

Part Master Data Set

The Part Master data set contains all part master records for a product, product line, plant, or company. A typical part master record contains identifying and descriptive data and control values (lead time, lot size, etc.). It may contain data on inventory status (such as quantities on hand), production plan (such as requirements, planned orders, etc.), and costs (Cox and Blackstone 1998). Each observation in this data set represents one part master record. If the data set contains more than one part master record for a given item, only the first one is used.

The BOM procedure uses the Part Master data set as input data with key variable names being used to identify the appropriate information. The **Part** variable contains

the part number or other information that uniquely identifies each item. This variable can be either a numeric or a character variable. The **LeadTime**, **QtyOnHand**, and **Requirement** variables contain the lead time, quantity on hand, and gross requirement, respectively, for the item identified by the **Part** variable. The **QtyOnHand** and **Requirement** variables are only used when the **SUMMARYOUT=** option is specified. The **QtyOnHand** variable enables you to include inventory information into the Part Master data set. Similarly, the **Requirement** variable enables you to specify a production plan in this data set. Other inventory and production plan information that is not directly used by the procedure can also be included in this data set and passed to the output data sets using the **ID** variables.

The value of the **Requirement** variable will typically be missing for most items, except for master schedule items. A *master schedule item* (MSI) is an item that is selected to be planned by the master scheduler. In general, final products are master schedule items. Some companies like to select a few items that are deemed critical in their impact on lower-level components or resources as master schedule items. The requirements of the master schedule items are also called *independent demands*. In the Part Master data set, if the value of the **Requirement** variable is greater than or equal to 0, the procedure treats the item identified by the **Part** variable as an MSI and assumes that its gross requirement is planned by the master scheduler. The gross requirements of other items (also known as the *dependent demands*) are determined by the procedure as the value of the net requirement of each parent item times the quantity required to make one unit of the parent item, summed over all the parent items. This process is called the *dependent demand process* (Clement, Coldrick, and Sari 1992). See the “**Summarized Parts Data Set**” section beginning on page 40 for details on determining gross and net requirements.

Other part master data such as part description, lot size, order quantity, unit of measure, unit of cost, or planner/buyer code can be passed to the **Indented BOM** and **Summarized Parts** output data sets using the **ID** variables.

Table 1.2 lists all the variables in this input data set, with their type and their interpretation by the BOM procedure. It also lists the options in the **STRUCTURE** statement that are used to identify these variables.

Table 1.2. Part Master Data Set and Associated Variables

Variable	Type	Option	Interpretation
ID	character or numeric	ID=	Additional master data for the item
LeadTime	numeric	LEADTIME=	Lead time of the item
Part	character or numeric	PART=	Part number or identification for the item
QtyOnHand	numeric	QTYONHAND=	Quantity of the item that is currently on hand
Requirement	numeric	REQUIREMENT=	Gross requirement of the item

You can combine the Part Master data set and the [Product Structure](#) data set together to create a new data set and use it as the input data set for PROC BOM. See the SIBOM1 data set shown in [Output 1.1.1](#) on page 45 and the SIBOM2 data set shown in [Output 1.2.1](#) on page 49 for examples.

Product Structure Data Set

The Product Structure data set lists all product structure records in a product, product line, plant, or company. Each product structure record defines the relationship of one component to its immediate parent item. It also includes quantity per assembly. The *quantity per assembly* is the quantity of the component that is required to make one unit of the parent item. A product structure record may contain fields for scrap factor, lead-time offset, and other information. The *scrap factor* of a parent-component relationship is used to increase the gross requirement of the component to account for anticipated loss within the manufacture of the parent item (Cox and Blackstone 1998). The *lead-time offset* of a parent-component relationship can be used to control when the component is issued to a work center while manufacturing the parent item, as well as to determine the need date when planning, purchasing, or manufacturing the component (Clement, Coldrick, and Sari 1992). Note that the lead-time offset may be expressed in a unit that is different from the lead time in the [Part Master](#) data set. For example, the lead time may be measured in weeks while the lead-time offset is measured in days or hours. If necessary, you can pass the unit that is used to measure the lead-time offset from this data set to the [Indented BOM](#) data set using the `RID=` option. Similarly, you can pass the unit for expressing the lead time to the [Indented BOM](#) and [Summarized Parts](#) data sets from the [Part Master](#) data set using the `ID=` option.

You can put more than one product structure record with the same parent item into one observation in this data set. See the SIBOM1 data set shown in [Output 1.1.1](#) on page 45 as an example. You can also include part master data in this data set. See [Example 1.1](#) on page 44 and [Example 1.2](#) on page 48 as examples.

The BOM procedure uses the Product Structure data set as input data with key variable names being used to identify the appropriate information. The [Parent](#) and [Component](#) variables contain the part numbers for the parent item and its components. These variables must be of the same type, format, and length as the [Part](#) variable in the [Part Master](#) data set. The [Quantity](#), [Factor](#), and [Offset](#) variables contain information for the quantity per assembly, scrap factor, and lead-time offset, respectively. Additional information for the parent-component relationships, such as engineering effectivity, point-of-use, operation number, reference designator, line sequence number, etc., can be passed to the [Indented BOM](#) data set using the `RID` variables.

[Table 1.3](#) lists all the variables in this input data set, with their type and their interpretation by the BOM procedure. It also lists the options in the `STRUCTURE` statement that are used to identify these variables.

Table 1.3. Product Structure Data Set and Associated Variables

Variable	Type	Option	Interpretation
Component	same as Part variable	COMPONENT=	Part number for the component
Factor	numeric	FACTOR=	Scrap factor for the relationship
Offset	numeric	OFFSET=	Lead-time offset for the relationship
Parent	same as Part variable	PARENT=	Part number for the parent item
Quantity	numeric	QUANTITY=	Quantity per assembly for the relationship
RID	character or numeric	RID=	Additional information about the relationship

A given component can be structured into a parent item more than once. The **Offset** variable (if the component is used at a different time in the process) and any **RID** variables (point-of-use, parent operation, line sequence number, etc.) can be used to distinguish product structure records with the same parent and component. See [Example 1.6](#) on page 66 as an example. If two or more product structure records have the same parent, component, lead-time offset, and values for all **RID** variables, the procedure handles them according to the specification of the **DUPLICATE=** option. If the value of the **DUPLICATE=** option is specified as the keyword **COMBINE**, the procedure combines these product structure records into one record. The quantity per assembly and the scrap factor of this new product structure record are determined as

$$q_0 = \sum_{i=1}^k q_i$$

and

$$f_0 = \frac{\sum_{i=1}^k (q_i \times f_i)}{q_0}$$

respectively, where

- k = number of identical product structure records
- f_0 = value of the scrap factor of the new product structure record
- f_i = value of the scrap factor of the i th identical product structure record

- q_0 = value of the quantity per assembly of the new product structure record
- q_i = value of the quantity per assembly of the i th identical product structure record

If the value of the `DUPLICATE=` option is specified as the keyword `DISCARD`, then the procedure keeps the first identical product structure record and discards the others. On the other hand, if the value of the `DUPLICATE=` option is specified as the keyword `KEEP`, PROC BOM keeps all identical product structure records and processes them independently.

Indented BOM Data Set

The Indented BOM data set produced by PROC BOM contains the indented bills of material for all final products in the `Part Master` data set, or for all end items specified in the `ENDITEM=` option. Each observation of this data set represents one indented BOM record. Information contained in each indented BOM record can be classified into three categories: part master data for the item identified by the `_Part_` variable, product structure data for the relationship of the component identified by the `_Part_` variable to its parent identified by the `_Parent_` variable, and data that are dedicated to this record.

As discussed in the “[Getting Started](#)” section beginning on page 18, each indented bill of material can be illustrated by a family tree. Each node in the family tree corresponds to a record in the Indented BOM data set. The indented BOM record that is associated with the root node of a family tree is distinguished as the *root record* of the indented bill of material. For a given indented BOM record and its corresponding node j , the *parent record* of record j is the indented BOM record that is associated with the parent node of node j . If the indented BOM record i is the parent record of record j , then record j is a *child record* of record i . Every record in the Indented BOM data set has a parent record except for the root records. Alternatively, an indented BOM record can have zero, one, two, or more child records.

Like the product structure record in the `Product Structure` data set, each indented BOM record in the Indented BOM data set contains a relationship of one component to its immediate parent item. The `_Part_` variable contains the part number or identification information of the component. The `_Parent_` variable contains the part number for the immediate parent item. Each record also contains all other product structure data from the product structure record with the same parent item (identified by the `Parent` variable) and component (identified by the `Component` variable) as in this record. The BOM procedure uses the following convention for naming the variable identifying the product structure data.

If you specify exactly one `Quantity` variable, the procedure uses the same variable name as specified in the `QUANTITY=` option for the variable that contains the value of the quantity per assembly for the relationship. On the other hand, if you do not specify the `QUANTITY=` option, or if you specify more than one `Quantity` variable,

the variable `Qty_Per` contains this value. If you do not specify the `QUANTITY=` option, the value of the quantity per assembly is 1 for all relationships. The procedure also uses the same variable name as specified in the `FACTOR=` option if only one `Factor` variable is specified, and uses the default name, `S_Factor`, if two or more `Factor` variables are specified, for the variable that contains the value of scrap factor. Similarly, if you specify more than one `Offset` variable, the default name, `L_Offset`, is used; if you specify only one `Offset` variable, the same variable name is used for the variable that contains the value of the lead-time offset. Note that if you do not specify the `FACTOR=` or `OFFSET=` options, the Indented BOM data set does not have variables that contain the values of scrap factor or lead-time offset, respectively. The Indented BOM data set has the same `RID` variables as in the `Product Structure` data set. The values of those variables for each record are copied from the product structure record with the same parent item and component. The values of the `_Parent_`, `Factor`, `Offset`, `Quantity`, and `RID` variables for any root records should be missing, if these variables are present.

Each record of the Indented BOM data set also contains part master data for the item identified by the `_Part_` variable in this indented BOM record. For instance, the lead time information is contained in the variable with the same variable name as specified in the `LEADTIME=` option. The Indented BOM data set also has the same `ID` variables as specified in the `ID=` option. The values of these variables for the indented BOM record are copied from the corresponding variables in the part master record for the same item (identified by the `_Part_` variable) in the Part Master data set.

In addition to the product structure and part master data, each record of the Indented BOM data set contains other data calculated by PROC BOM. The `_Prod_` variable contains the part number for the final product or end item of the indented bill of material corresponding to this record. For any root records, the value of the `_Prod_` variable is the same as the value of the `_Part_` variable. The `_Level_` variable contains the indenture level number of the record. The procedure assigns the value of the indenture level to each record as follows: Each root record has indenture level 0, and all child records corresponding to a root record have level 1. All subsequent child records of these records have the level number increased by 1. This process continues until there are no further child records. The `Part_ID` variable contains the sequence or ID number that uniquely identifies each record in this data set. PROC BOM assigns this sequence number to each record in the data set by using the *depth-first numbering* scheme (Aho, Hopcroft, and Ullman 1983). The `Paren_ID` variable contains the ID number for the immediate parent record. The value of the `Paren_ID` variable for a root record is missing. These two variables are useful when you use the Indented BOM data set as the input data set for other SAS/OR procedures, such as PROC NETDRAW and PROC CPM, which require unique identification of each node. Refer to “The NETDRAW Procedure” and “The CPM Procedure” chapters in the *SAS/OR User’s Guide: Project Management* for details.

The `Qty_Prod` variable denotes the quantity of the item (identified by the `_Part_` variable) required to make one unit of the end item identified by the `_Prod_` variable.

This value is also known as *quantity per product* and can be determined as

$$qp_i = \begin{cases} 1 & \text{if } j \text{ is missing} \\ qp_j \times q_i & \text{otherwise} \end{cases}$$

where

- i = the value for the **Part_ID** variable
- j = the value for the **Paren_ID** variable
- qp_i = the quantity per product of record i
- q_i = the quantity per assembly of record i

If the **LEADTIME=** option is specified, PROC BOM measures the total lead time accumulated from the root record to the current record and stores it in the **Tot_Lead** variable. The formula to determine the total lead time for each record is

$$tl_i = \begin{cases} t_i & \text{if } j \text{ is missing} \\ tl_j + t_i & \text{otherwise} \end{cases}$$

where

- i = the value for the **Part_ID** variable
- j = the value for the **Paren_ID** variable
- t_i = the lead time of record i
- tl_i = the total lead time of record i

Similarly, if the **OFFSET=** option is specified, the procedure computes the total offset from the root record to the current record and stores it in the **Tot_Off** variable. The total offset for each record can be determined as

$$to_i = \begin{cases} o_i & \text{if } j \text{ is missing} \\ to_j + o_i & \text{otherwise} \end{cases}$$

where

- i = the value for the **Part_ID** variable
- j = the value for the **Paren_ID** variable
- o_i = the lead-time offset of record i
- to_i = the total offset of record i

Note that the lead-time offset and the total offset may be expressed in a unit that is different from the lead time and the total lead time in this data set.

Table 1.4 lists all the variables in the Indented BOM data set. It also lists the type and a brief description of these variables.

Table 1.4. Indented BOM Data Set and Associated Variables

Product Structure Data (for the parent-component relationship)		
Variable	Type	Interpretation
Factor	numeric	Scrap factor
Offset	numeric	Lead-time offset
Parent	same as _Part_	Part number for the parent item
Part	character or numeric	Part number for the component
Quantity	numeric	Quantity per assembly
RID	character or numeric	Additional product structure data
Part Master Data (for the component)		
Variable	Type	Interpretation
ID	character or numeric	Additional part master data
LeadTime	numeric	Lead time
Indented BOM Data (for the record)		
Variable	Type	Interpretation
Level	numeric	Indenture level number
Paren_ID	numeric	ID number of the parent record
Part_ID	numeric	ID number
Prod	same as _Part_	Part number for the end item
Qty_Prod	numeric	Quantity per product
Tot_Lead	numeric	Total lead time
Tot_Off	numeric	Total lead-time offset

The indented BOM records in this data set are organized so that the bills of material contained in the data set are listed one by one. In each bill of material, the root record is always listed first. In addition, the left-most (oldest) component of each parent item is listed directly after its parent and before any right siblings of the parent item. For example, from the Indented BOM data shown in Figure 1.3 on page 20, you can easily see that the final product 'LA01' is the first record of the Indented BOM data set. Moreover, item '1100' is listed directly after its parent, 'B100', and before the items 'S100' and 'A100' (the right siblings of the item 'B100'). The item '1100' is followed immediately by its first component '2100' (the only component in this case), and so on.

By organizing indented BOM records in such a manner and using the indenture level information, the single-level and multilevel relationships are quite clear. Let us use the indented BOM data set displayed in Figure 1.3 on page 20 as an example. The

three components, 'B100', 'S100', and 'A100', that go into 'LA01' are easily determined by the level 1 identifiers. It is also easy to see that item 'A100' takes three components at level 2, and one of them, item '1500', has a level 3 component (item '1400') and another item, '1700', has two level 3 components (items '2200' and '2300'). In fact, record 1 to record 6 of this data set contain the indented bill of material for item 'B100' because record 7 is the first record to have the same level as record 1. The *single-level where-used* and *indented where-used* lists can also be done in the same manner but by retrieving records in reversed order. For example, items 'B100' and '1500' that directly use component '1400' can be detected either by looking at the values of the `_Parent_` variable directly in record 6 and record 10, or by looking up at the first records with level numbers that are 1 less than record 6 and record 10, respectively. By continuing to look upward, you see that item '1500' is used in 'A100' and item 'A100' is used in 'LA01'. As discussed previously, you can also find the parent record (the first record with one level up while retrieving the data in reversed order) information in the `Paren_ID` variable. The Indented BOM data set can also be used to propagate gross requirements, determine a schedule of lower-level items needed, aggregate lower-level demands, roll up material costs, and so on. See the “[Bill of Material Explosion and Implosion](#)” section beginning on page 38 for details.

Bill of Material Explosion and Implosion

As described previously, the records (or observations) in the [Indented BOM](#) data set are organized in depth-first order (Aho, Hopcroft, and Ullman 1983). The order of observations in the [Indented BOM](#) data set and the presence of the `_Level_` variable make it possible to perform bill of material explosion and implosion easily. In fact, the [Indented BOM](#) data set contains the quantity per product, total lead time, and total lead-time offset data already. The [Summarized Parts](#) data set lists the gross and net requirements for each item to fill a given production plan. Other calculations can be performed using a simple SAS DATA step. For example, the following SAS code creates a single-level bill of material for the item 'LA01' from the [Indented BOM](#) data set, `IndBOM0`, as displayed in [Figure 1.3](#) on page 20. The single-level bill of material is shown in [Figure 1.6](#).

```

/* Display the components that are directly used */
/* in item LA01 */
proc print data=IndBOM0 (where=( _Parent_='LA01')
                          rename=( _Part_ =Component))
      noobs;
var Component Desc QtyPer Unit;
title 'ABC Lamp Company';
title3 'Single-level Bill of Material Retrieval, Part LA01';
run;

```

ABC Lamp Company			
Single-level Bill of Material Retrieval, Part LA01			
Component	Desc	Qty Per	Unit
B100	Base assembly	1	Each
S100	Black shade	1	Each
A100	Socket assembly	1	Each

Figure 1.6. Components Directly Used in Part LA01

The single-level where-used list for item '1400', displayed in [Figure 1.7](#), is created with the following SAS code. PROC SQL is invoked to link the part master data to each parent item.

```

/* Create the where-used data set */
data Used0a(keep=_Parent_ Paren_ID QtyPer Unit);
  set IndBOM0(where=( _Part_='1400' ));
run;

/* Get the part description from the IndBOM0 data set */
proc sql;
  create table Used0b as
  select Used0a._Parent_, IndBOM0.Desc,
         Used0a.QtyPer, Used0a.Unit
  from Used0a left join IndBOM0
         on Used0a.Paren_ID=IndBOM0.Part_ID;
quit;

/* Display the where-used data set */
proc print data=Used0b noobs;
  var _Parent_ Desc QtyPer Unit;
  title 'ABC Lamp Company';
  title3 'Single-level Where-used Report, Part 1400';
run;

```

ABC Lamp Company			
Single-level Where-used Report, Part 1400			
Parent	Desc	Qty Per	Unit
B100	Base assembly	4	Each
1500	Steel holder	2	Each

Figure 1.7. Parents in which Part 1400 is Directly Used

The “Reporting Macros” section (beginning on page 91) in Chapter 2, “Bill-of-Material Post-Processing Macros,” describes six SAS autocall macros that can be used to create single-level, indented, and summarized bills of material and where-used lists for an item from the Indented BOM data set. Example 1.8 on page 73 demonstrates a simple way to roll up costs using SAS DATA step code. Similar techniques can be used to aggregate lower level requirements up to the end items or to perform other bill of material explosion and implosion. See Example 1.9 on page 76 and Example 1.10 on page 79 for further examples.

Summarized Parts Data Set

If the `SUMMARYOUT=` option in the `PROC BOM` statement is specified, the BOM procedure creates a Summarized Parts data set. This data set lists all the items with their quantities required (needed to be made or ordered) in order to fill the production plan specified in the Part Master data set, taking into account the quantities of these items on hand in the planning period. This data set lists each item once for the total quantity needed. Each observation in this data set represents one record, which is uniquely identified by the part number in the `_Part_` variable. Each record contains all part master data (from the Part Master data set) for the item identified by the `_Part_` variable. Each record also contains fields for net requirement and low-level code.

The `_Part_` variable contains the part number or identification information of the item. The data set has the same `LeadTime`, `QtyOnHand`, `Requirement`, and all `ID` variables as in the Part Master data set. If you do not specify the `QTYONHAND=` option, the default name, `On_Hand`, is used to name the variable that contains the quantity of the item identified by the `_Part_` variable that is currently on hand in the planning period. The default value of this variable is 0, since the procedure assumes there are no items on hand if the `QTYONHAND=` option is not specified. Similarly, if the `REQUIREMENT=` option is not specified, the default name `Gros_Req` is used to name the variable that contains the value of the gross requirement for the item identified by the `_Part_` variable. The values for these variables, except for the variable that contains the gross requirement, are carried from the Part Master data set. The gross requirements for all items, except for master schedule items, are determined by the dependent demand process, which is described later.

The `Net_Req` variable contains the value of the net requirement and the `Low_Code` variable contains the value of the low-level code for the item identified by the `_Part_` variable. The low-level code of an item is the lowest indenture level in any bill of material containing the item. The low-level codes are necessary to make sure that the net requirement of any item is not calculated until all the gross requirements have been calculated down to that level.

The gross and net requirements for all items are determined in the order of increasing low-level codes. Start at an item with the smallest low-level code (usually 0). If an item *c* is a master schedule item, the gross requirement for this item is carried from

the **Part Master** data set. Otherwise, it is given by

$$R_c = \sum_{\text{all}(p,c)\text{in}\mathfrak{R}} [N_p \times q_{(p,c)} \times (1 + e_{(p,c)})]$$

and the net requirement is determined as

$$N_c = \begin{cases} R_c - H_c & \text{if } R_c > H_c \\ 0 & \text{otherwise} \end{cases}$$

where

- (p, c) = a relationship between the parent item p and the component c
- \mathfrak{R} = a collection of all parent-component relationships that are defined in the Indented BOM data set
- R_c = the gross requirement for the item c
- N_c = the net requirement for the item c
- H_c = the quantity on hand for the item c
- $q_{(p,c)}$ = the quantity per assembly for the relationship (p, c)
- $e_{(p,c)}$ = the scrap factor for the relationship (p, c)

This computational process continues for items with larger low-level codes until the values of the gross and net requirements for all components in the **Indented BOM** data set have been determined. This computational process is known as the *dependent demand process*.

A summarized parts list should not be confused with a summarized bill of material. As discussed previously, a summarized parts list shows all the items and their quantities required to fill a pre-specified production plan. The gross and net requirements in this list are calculated taking into account the quantity of each item that is available in the planning period. On the other hand, a summarized bill of material for a pre-specified item lists all the components and their total quantities used in making one batch of that item, without any regard for quantities of items on hand. In a special case when the input data do not contain any requirement, quantity on hand, or scrap factor information, and the **Indented BOM** data set contains only one end item, then the summarized parts list in this data set happens to be the same as the summarized bill of material for the end item.

Table 1.5 lists all the variables in the Summarized Parts data set. It also lists the type and a brief description of these variables.

Table 1.5. Summarized Parts Data Set and Associated Variables

Variable	Type	Interpretation
ID	character or numeric	Additional master data for the item
LeadTime	numeric	Lead time for the item
Low_Code	numeric	Low-level code for the item
Net_Req	numeric	Net requirement for the item
Part	character or numeric	Part number for the item
QtyOnHand	numeric	Quantity of the item that is currently on hand
Requirement	numeric	Gross requirement for the item

Missing Values in the Input Data Sets

The following table summarizes the treatment of missing values for variables in the input data sets used by PROC BOM.

Table 1.6. Treatment of Missing Values in the BOM Procedure

Data Set	Variable	Value Used/Assumption Made/Action Taken
Part Master	ID	missing, if Part is not missing; otherwise ignored
	LeadTime	0, if Part is not missing; otherwise ignored
	Part	value ignored
	QtyOnHand	0, if Part is not missing; otherwise ignored
	Requirement	ignored if Part is missing; 1, if Part is not missing and the item identified by the Part variable is an end item; otherwise, the value is determined by the procedure
Product Structure	Component	value ignored
	Factor	0, if corresponding Component variable is not missing; otherwise ignored
	Offset	0, if corresponding Component variable is not missing; otherwise ignored
	Parent	input error: procedure stops with error message, if this is the first observation; otherwise, the value of the Parent variable in the previous observation

Table 1.6. (continued)

Data Set	Variable	Value Used/Assumption Made/Action Taken
	Quantity	1, if corresponding Component variable is not missing; otherwise ignored
	RID	missing, if corresponding Component variable is not missing; otherwise ignored

Note that in the **Product Structure** data set, a missing value is allowed for the **Parent** variable only when two or more consecutive observations contain product structure records with the same parent item (see **Output 1.1.1** on page 45 and **Output 1.3.2** on page 55 as examples). In the **Part Master** data set, if the **Part** variable is missing, the values for the **ID**, **LeadTime**, **QtyOnHand**, and **Requirement** variables are ignored by the procedure. If the **Part** variable is not missing but the **Requirement** variable value is missing, the gross requirement of the item identified by the **Part** variable is assumed to be 1 if the item in question is an end item. Otherwise, the gross requirement of this item is determined based on the dependent demand process. See the “**Summarized Parts Data Set**” section on page 40 for details about the dependent demand process.

Macro Variable `_ORBOM_`

The BOM procedure defines a macro variable named `_ORBOM_`. This variable contains a character string that indicates the status of the procedure. It is set at procedure termination. The form of the `_ORBOM_` character string is `STATUS= REASON=`, where `STATUS=` is either `SUCCESSFUL` or `ERROR_EXIT`, and `REASON=` (if `PROC BOM` terminated unsuccessfully) can be one of the following:

CYCLE
 BADDATA_ERROR
 MEMORY_ERROR
 IO_ERROR
 SEMANTIC_ERROR
 SYNTAX_ERROR
 BOM_BUG
 UNKNOWN_ERROR

This information can be used when `PROC BOM` is one step in a larger program that needs to determine whether the procedure terminated successfully. Because `_ORBOM_` is a standard SAS macro variable, it can be used in the ways that all macro variables can be used.

Computer Resource Requirements

There is no inherent limit on the size of the problem that can be handled with the BOM procedure. The number of items and relationships are constrained only by the amount of memory available. Naturally, there needs to be a sufficient amount of core memory available in order to invoke and initialize the SAS System. As far as possible, the procedure attempts to store all the data in core memory.

However, if the problem is too large to fit in core memory, the procedure resorts to the use of utility data sets and swaps between core memory and utility data sets as necessary, unless the `NOUTIL` option is specified. The procedure uses the `NPARTS=` and `NRELTS=` options to determine approximate problem size. If these options are not specified, the procedure estimates default values on the basis of the number of observations in the `Product Structure` and `Part Master` data sets. See the “`PROC BOM Statement`” section (beginning on page 25) for default specifications.

The storage requirement for the data area and the time required by the procedure are proportional to the numbers of items and parent-component relationships in the problem.

Examples

This section contains examples that illustrate the features of the BOM procedure. Most of the examples use the data from the ABC Lamp Company product line described in the “`Getting Started`” section beginning on page 18.

Example 1.1. Bill of Material with Single Input Data Set

This example uses a single input data set for invoking the BOM procedure. It also demonstrates the use of `PROC NETDRAW` to draw a tree diagram for the indented bill of material contained in the `Indented BOM` output data set. The input data set, `SIBOM1`, is depicted in [Output 1.1.1](#). Each observation of this data set contains up to 3 product structure records. It also contains part master data, namely, the part description denoted by the `Desc` variable and the unit of measure denoted by the `Unit` variable, for the item identified by the value of the `Parent` variable. Note that the parent item ‘B100’ has 4 components, causing the specification to require two observations. The values of the `Parent`, `Desc`, and `Unit` variables for the second observation are missing because they have the same values as the previous observation.

Output 1.1.1. The Input Data Set (SIBOM1)

ABC Lamp Company								
PROC BOM Input Data Set								
Parent	Desc	Unit	Comp1	Comp2	Comp3	Qty1	Qty2	Qty3
LA01	Lamp LA	Each	B100	S100	A100	1	1	1
B100	Base assembly	Each	1100	1200	1300	1	1	1
			1400			4	.	.
S100	Black shade	Each				.	.	.
A100	Socket assembly	Each	1500	1600	1700	1	1	1
1100	Finished shaft	Each	2100			26	.	.
1200	6-Diameter steel plate	Each				.	.	.
1300	Hub	Each				.	.	.
1400	1/4-20 Screw	Each				.	.	.
1500	Steel holder	Each	1400			2	.	.
1600	One-way socket	Each				.	.	.
1700	Wiring assembly	Each	2200	2300		12	1	.
2100	3/8 Steel tubing	Inches				.	.	.
2200	16-Gauge lamp cord	Feet				.	.	.
2300	Standard plug terminal	Each				.	.	.

The following code invokes PROC BOM to produce the indented bill of material and the summarized parts list. The indented bill of material is displayed in [Output 1.1.2](#), and the summarized parts list, which has been sorted by the `_Part_` variable, is displayed in [Output 1.1.3](#). These are exactly the same as the indented bill of material shown in [Figure 1.3](#) on page 20 and the summarized parts list shown in [Figure 1.5](#) on page 22.

```

/* Create the indented BOM and the summarized parts list */
proc bom data=S1BOM1 out=IndBOM1 summaryout=SumBOM1;
  structure / part=Parent
             parent=Parent
             component=(Comp1-Comp3)
             quantity=(Qty1-Qty3)
             id=(Desc Unit);
run;

```

Output 1.1.2. Indented Bill of Material (IndBOM1)

ABC Lamp Company								
Indented Bill of Material, Part LA01								
Q	P							
t	a							
Y	r							
—	e							
P	n							
e	o							
r	d							
0		LA01	Lamp LA	.	1	Each	.	0 LA01
1	LA01	B100	Base assembly	1	1	Each	0	1 LA01
2	B100	1100	Finished shaft	1	1	Each	1	2 LA01
3	1100	2100	3/8 Steel tubing	26	26	Inches	2	3 LA01
2	B100	1200	6-Diameter steel plate	1	1	Each	1	4 LA01
2	B100	1300	Hub	1	1	Each	1	5 LA01
2	B100	1400	1/4-20 Screw	4	4	Each	1	6 LA01
1	LA01	S100	Black shade	1	1	Each	0	7 LA01
1	LA01	A100	Socket assembly	1	1	Each	0	8 LA01
2	A100	1500	Steel holder	1	1	Each	8	9 LA01
3	1500	1400	1/4-20 Screw	2	2	Each	9	10 LA01
2	A100	1600	One-way socket	1	1	Each	8	11 LA01
2	A100	1700	Wiring assembly	1	1	Each	8	12 LA01
3	1700	2200	16-Gauge lamp cord	12	12	Feet	12	13 LA01
3	1700	2300	Standard plug terminal	1	1	Each	12	14 LA01

Output 1.1.3. Summarized Parts List (SumBOM1)

ABC Lamp Company							
Summarized Parts List, Period 1							
Part	Low Code	Gros Req	On Hand	Net Req	Desc		Unit
1100	2	1	0	1	Finished shaft		Each
1200	2	1	0	1	6-Diameter steel plate		Each
1300	2	1	0	1	Hub		Each
1400	3	6	0	6	1/4-20 Screw		Each
1500	2	1	0	1	Steel holder		Each
1600	2	1	0	1	One-way socket		Each
1700	2	1	0	1	Wiring assembly		Each
2100	3	26	0	26	3/8 Steel tubing		Inches
2200	3	12	0	12	16-Gauge lamp cord		Feet
2300	3	1	0	1	Standard plug terminal		Each
A100	1	1	0	1	Socket assembly		Each
B100	1	1	0	1	Base assembly		Each
LA01	0	1	0	1	Lamp LA		Each
S100	1	1	0	1	Black shade		Each

As discussed in the “[Summarized Parts Data Set](#)” section beginning on page 40, since item ‘LA01’ is the only master schedule item in this example, and both the quantity on hand and the scrap factor are zero for all items, the summarized parts list displayed in [Output 1.1.3](#) is also the summarized bill of material for item ‘LA01’.

The following SAS code uses PROC NETDRAW to draw a *family tree* diagram displaying the indented bill of material for item ‘LA01’. The NETDRAW procedure requires the descriptive information for each node to be associated with the parent node in each observation. However, the Indented BOM data set contains the descriptive (part master) information for the component identified by the `_Part_` variable. Thus, the following code prepares the data for PROC NETDRAW. This code first creates two data sets from the Indented BOM data set, `IndBOM1`. The `IndBOM1a` data set contains all variables in the Indented BOM data set, except for the `Part_ID` variable. The `Part_ID` variable is dropped and its value is copied to the `Paren_ID` variable. Each record in this data set is represented by a tree node in the diagram, which is uniquely identified by the value of the `Paren_ID` variable. The other data set, `IndBOM1b`, contains all parent-component relationships, in which each relationship is identified by the `Paren_ID` and `Part_ID` variables. Each observation in this data set is represented by a link in the diagram. These two data sets are concatenated to form the input data set for PROC NETDRAW. The tree diagram for the indented bill of material for item ‘LA01’ is displayed in [Output 1.1.4](#). For further details about the NETDRAW procedure, refer to Chapter 5, “The NETDRAW Procedure,” (*SAS/OR User’s Guide: Project Management*).

```

/* Draw a tree diagram for illustrating the product structure */
/* Each record denotes a node in the tree */
data IndBOM1a(drop=Part_ID);
  set IndBOM1;
  Paren_ID=Part_ID;
run;

/* Extract the Parent-Component information */
data IndBOM1b;
  set IndBOM1(keep=Paren_ID Part_ID);
run;

/* Prepare the data set for running NETDRAW */
data TreBOM1;
  set IndBOM1a IndBOM1b;
run;

/* Specify graphics options */
goptions hpos=32 vpos=80 border;
pattern1 v=s c=white;

title h=5 j=c 'Multilevel Bill of Material Diagram';
footnote h=2 j=1
  'Node shows ID Number, Part Number, and Quantity Required';

```

```

/* Invoke PROC NETDRAW to display BOM tree */
proc netdraw data=TreBOM1( where=(Paren_ID NE .) );
  actnet / act=Paren_ID succ=Part_ID id=(Paren_ID _Part_ QtyPer)
         ctext=black font=swiss htext=3 carcs=black
         ybetween=3 xbetween=8 centerid
         tree pcompress rotatetext rotate
         arrowhead=0 rectilinear nodefid nolabel;
run;

```

Output 1.1.4. Tree Diagram for the Bill of Material

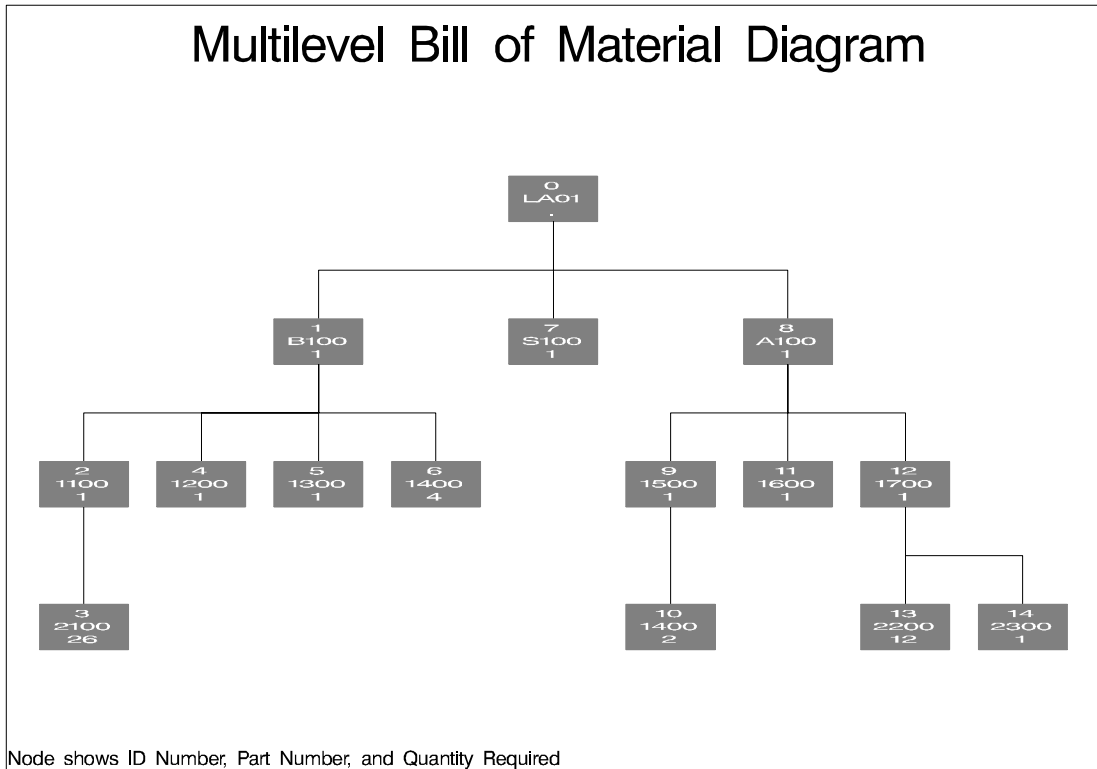

Example 1.2. Bill of Material with Lead Time Information

As in [Example 1.1](#) on page 44, this example also uses a single input data set with each observation containing product structure data and part master data. Unlike the SIBOM1 data set (shown in [Output 1.1.1](#) on page 45) in which each observation contains three product structure records, each observation in the input data set SIBOM2, as depicted in [Output 1.2.1](#), contains only one product structure record. The observations in both input data sets also contain one part master record. However, in the previous example, the variable `Parent` contains the part number for the part master record, whereas in the current example, the part number for the part master record is contained in the variable `Component`. In addition, in this example, each part master record also contains requirement (contained in the `Gros_Req` variable) and quantity on hand (contained in the `On_Hand` variable) information.

Output 1.2.1. The Input Data Set (SIBOM2)

ABC Lamp Company							
PROC BOM Input Data Set							
Parent	Component	Desc	Unit	Lead Time	Qty Per	Gros_Req	On_Hand
	LA01	Lamp LA	Each	2	.	50	20
LA01	B100	Base assembly	Each	1	1	.	50
LA01	S100	Black shade	Each	2	1	.	.
LA01	A100	Socket assembly	Each	1	1	.	.
B100	1100	Finished shaft	Each	2	1	.	.
B100	1200	6-Diameter steel plate	Each	3	1	.	.
B100	1300	Hub	Each	2	1	.	.
B100	1400	1/4-20 Screw	Each	1	4	.	.
A100	1500	Steel holder	Each	2	1	.	.
A100	1600	One-way socket	Each	2	1	.	.
A100	1700	Wiring assembly	Each	1	1	.	.
1100	2100	3/8 Steel tubing	Inches	3	26	.	.
1500	1400	1/4-20 Screw	Each	1	2	.	.
1700	2200	16-Gauge lamp cord	Feet	2	12	.	.
1700	2300	Standard plug terminal	Each	1	1	.	.

The following code produces the Indented BOM data set and the Summarized Parts data set. The Indented BOM data set, `IndBOM2`, is displayed in [Output 1.2.2](#). The “PART=Component” specification in the STRUCTURE statement indicates that the Component variable contains the part number for the part master record in each observation. Since the LEADTIME= option is specified, a new variable, `Tot_Lead`, has been added to the Indented BOM data set. This variable denotes the total lead time accumulated from the root record (the top-most record) to the record identified by the value of the `Part_ID` variable.

```

/* Create the indented BOM and the summarized parts list */
proc bom data=SIBOM2 out=IndBOM2 summaryout=SumBOM2;
  structure / part=Component
             leadtime=LeadTime
             parent=Parent
             component=Component
             quantity=QtyPer
             qtyonhand=On_hand
             requirement=Gros_Req
             id=(Desc Unit);
run;

```

Output 1.2.2. Indented Bill of Material with Lead Time (IndBOM2)

ABC Lamp Company									
Indented Bill of Material, Part LA01									
Q	L	T							
t	e	o							
Y	a	t							
P	U	T							
r	n	L							
e	i	e							
r	d	e							
d	t	d							
0	LA01	LA01	Lamp LA	.	1	Each	2	2	LA01
1	LA01	B100	Base assembly	1	1	Each	1	3	LA01
2	B100	1100	Finished shaft	1	1	Each	2	5	LA01
3	1100	2100	3/8 Steel tubing	26	26	Inches	3	8	LA01
2	B100	1200	6-Diameter steel plate	1	1	Each	3	6	LA01
2	B100	1300	Hub	1	1	Each	2	5	LA01
2	B100	1400	1/4-20 Screw	4	4	Each	1	4	LA01
1	LA01	S100	Black shade	1	1	Each	2	4	LA01
1	LA01	A100	Socket assembly	1	1	Each	1	3	LA01
2	A100	1500	Steel holder	1	1	Each	2	5	LA01
3	1500	1400	1/4-20 Screw	2	2	Each	1	6	LA01
2	A100	1600	One-way socket	1	1	Each	2	5	LA01
2	A100	1700	Wiring assembly	1	1	Each	1	4	LA01
3	1700	2200	16-Gauge lamp cord	12	12	Feet	2	6	LA01
3	1700	2300	Standard plug terminal	1	1	Each	1	5	LA01

Output 1.2.3. Summarized Parts List (SumBOM2)

ABC Lamp Company									
Summarized Parts List, Period 2									
Lead									
Part	Low Code	Gros Req	On Hand	Net Req	Time	Desc	Unit		
1100	2	0	0	0	2	Finished shaft	Each		
1200	2	0	0	0	3	6-Diameter steel plate	Each		
1300	2	0	0	0	2	Hub	Each		
1400	3	60	0	60	1	1/4-20 Screw	Each		
1500	2	30	0	30	2	Steel holder	Each		
1600	2	30	0	30	2	One-way socket	Each		
1700	2	30	0	30	1	Wiring assembly	Each		
2100	3	0	0	0	3	3/8 Steel tubing	Inches		
2200	3	360	0	360	2	16-Gauge lamp cord	Feet		
2300	3	30	0	30	1	Standard plug terminal	Each		
A100	1	30	0	30	1	Socket assembly	Each		
B100	1	30	50	0	1	Base assembly	Each		
LA01	0	50	20	30	2	Lamp LA	Each		
S100	1	30	0	30	2	Black shade	Each		

The data set `SumBOM2` displayed in [Output 1.2.3](#) contains the sorted summarized parts list for the production plan, in which 50 units of 'Lamp LA' are planned (say, in period 2). Based on the input data, 'Lamp LA' has 20 units and 'Base assembly' has 50 units currently on hand. The gross requirements of 30 units for 'B100', 'S100', and 'A100' are from the net requirement of 'LA01' (computed as `Gros_Req - On_Hand`). Since item 'B100' has 50 units on hand, which is more than its gross requirement, the net requirement of this item is 0. This implies that the gross requirements for '1100', '1200', and '1300' (components of the item 'B100') are all 0. However, the gross requirement for item '1400', which is also a component of 'B100', is not 0 but 60. This is due to the fact that item '1400' is also used in item '1500'.

The following code uses the Indented BOM data set produced in the previous invocation of `PROC BOM` to create a data set that can be used by the `NETDRAW` procedure.

```

      /* Prepare the data set for running NETDRAW */
data IndBOM2a(drop=Part_ID);
  set IndBOM2;
  Paren_ID=Part_ID;
run;

data IndBOM2b;
  set IndBOM2(keep=Paren_ID Part_ID);
run;

data TreBOM2;
  set IndBOM2a IndBOM2b;
  LTnQP = put(LeadTime, f3.)||"  "||put(QtyPer, f3.);
run;

```

`PROC NETDRAW` is invoked with the `NODISPLAY` option to create a data set (`Layout2`) that contains all the layout information for the tree structure. The `OUT=` option specifies the name of the layout data set:

```

      /* Specify graphics options */
title h=1 j=c 'Bill of Material Diagram with Lead-time Offsetting';
footnote h=0.5 j=1
  'Node shows Part Number, Lead-time, and Quantity Required';
pattern1 v=e c=gray;

      /* Get the layout information for the BOM tree */
proc netdraw data=TreBOM2( where=(Paren_ID NE .) )
  out=Layout2 nodisplay;
  actnet / act=Paren_ID succ=Part_ID id=( _Part_ LTnQP Tot_Lead)
  ybetween=3 xbetween=15 tree
  rectilinear nodefid nolabel;
run;

```

In the next invocation, PROC NETDRAW uses a modified layout of the nodes to produce a diagram where the nodes are aligned according to the total lead time. The resulting tree diagram is shown in [Output 1.2.4](#). Refer to Chapter 5, “The NETDRAW Procedure,” (*SAS/OR User’s Guide: Project Management*) for details on the NETDRAW procedure.

```
/* Lead time offset the X coordinate of each node */
data TreBOM2a;
  set Layout2;
  if _seq_ = 0;
  drop _seq_;
  _x_ = Tot_Lead;
run;

/* Display the BOM tree with lead-time offsetting */
proc netdraw data=TreBOM2a;
  actnet / id=( _Part_ LTnQP)
          font=swiss ctext=black htext=3 carcs=black
          align=Tot_Lead frame pcompress
          xbetween=15 ybetween=3
          arrowhead=0 rectilinear nodefid nolabel;
run;
```

Output 1.2.4. Bill of Material Diagram with Lead-time Offsetting

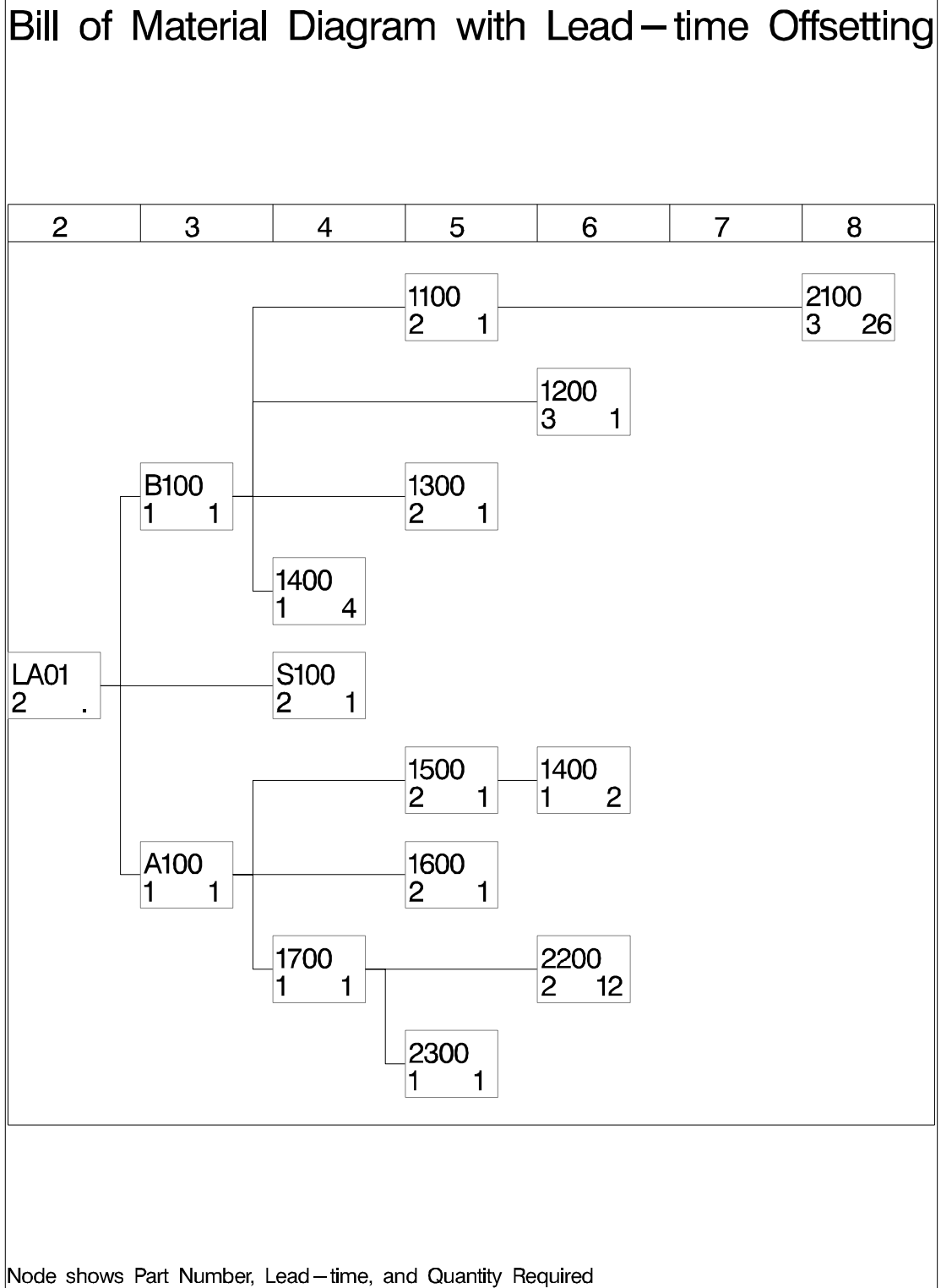

Example 1.3. Bill of Material with Scrap Factor Information

As in the introductory example described in the “Getting Started” section (beginning on page 18), this example uses two data files, PMaster3 and ParComp3, as input data sets for the BOM procedure. The PMaster3 data set, shown in Output 1.3.1, lists the part master records for all items of the ABC Lamp Company. The Part and Desc variables contain the part number and description, respectively. The Unit and LeadTime variables contain the unit of measure and lead time information for the item identified by the Part variable. The ParComp3 data set (shown in Output 1.3.2) lists all product structure records in the company. The Parent and the Component variables contain the part numbers for the parent item and the component, respectively. The QtyPer, Fscrap, and LTOff variables contain the quantity per assembly, scrap factor, and lead-time offset information, respectively, for the relationship identified by the Parent and Component variables. The SDate and EDate variables are the start and end dates for the *bill of material effectivity dates*. The effectivity dates are used to determine when a component is active as a part of the bill of material. In this example, item ‘1700’ uses component ‘2200’ until the end of the 7th of April, 2001. Starting on April 8, 2001, item ‘1700’ uses component ‘2210’ instead. Refer to Landvater and Gray (1989) for more information about bill of material effectivity dates.

Output 1.3.1. Part Master Data Set (PMaster3)

ABC Lamp Company			
Part Master Records			
Part	Desc	Unit	Lead Time
1100	Finished shaft	Each	2
1200	6-Diameter steel plate	Each	3
1300	Hub	Each	2
1400	1/4-20 Screw	Each	1
1500	Steel holder	Each	2
1600	One-way socket	Each	2
1700	Wiring assembly	Each	1
2100	3/8 Steel tubing	Inches	3
2200	16-Gauge lamp cord	Feet	2
2210	14-Gauge lamp cord	Feet	2
2300	Standard plug terminal	Each	1
A100	Socket assembly	Each	1
B100	Base assembly	Each	1
LA01	Lamp LA	Each	2
S100	Black shade	Each	2

Output 1.3.2. Product Structure Data Set (ParComp3)

ABC Lamp Company						
Product Structure Records						
Parent	Component	Qty Per	Fscrap	LTOff	SDate	EDate
LA01	B100	1
	S100	1
	A100	1	.	2	.	.
B100	1100	1
	1200	1
	1300	1	.	1	.	.
	1400	4	.	3	.	.
A100	1500	1
	1600	1
	1700	1
1100	2100	26	0.2	.	.	.
1500	1400	2
1700	2200	12	0.1	.	.	07APR2001
	2210	12	0.1	.	08APR2001	.
	2300	1

The following code invokes PROC BOM to produce the indented bill of material and the summarized parts list.

```

/* Create the indented BOM with lead time */
proc bom data=ParComp3 pmdata=PMaster3
      out=IndBOM3 summaryout=SumBOM3;
  structure / part=Part
            leadtime=LeadTime
            parent=Parent
            component=Component
            quantity=QtyPer
            factor=Fscrap
            offset=LTOff
            id=(Desc Unit)
            rid=(SDate EDate);
run;

```

The indented bill of material in [Output 1.3.3](#) is similar to the one displayed in [Output 1.2.2](#) on page 50, with additional fields for scrap factor, lead-time offset, total offset, and the start and end effectivity dates. The values of scrap factor, lead-time offset and the effectivity dates are carried from the product structure input data set shown in [Output 1.3.2](#). The value of the total offset (denoted by the `Tot_Off` variable) is determined by the procedure as the total lead-time offset accumulated from the end item identified by the `_Prod_` variable to the item identified by the `_Part_` variable. In addition, the value of the quantity per product (denoted by the `Qty_Prod` variable) for each record of this indented bill of material has been increased by the scrap factor to account for anticipated loss within the manufacture of the product 'LA01'. See the “[Indented BOM Data Set](#)” section on page 34 for information about determining the quantity per product when scrap factor is in effect.

Output 1.3.3. Indented Bill of Material with Scrap Factor (IndBOM3)

ABC Lamp Company								
Indented Bill of Material, Part LA01								
Obs	Level	Parent	Part	Desc	Qty Per	Fscrap	Qty Prod	
1	0		LA01	Lamp LA	.	.	1	
2	1	LA01	B100	Base assembly	1	0.0	1	
3	2	B100	1100	Finished shaft	1	0.0	1	
4	3	1100	2100	3/8 Steel tubing	26	0.2	26	
5	2	B100	1200	6-Diameter steel plate	1	0.0	1	
6	2	B100	1300	Hub	1	0.0	1	
7	2	B100	1400	1/4-20 Screw	4	0.0	4	
8	1	LA01	S100	Black shade	1	0.0	1	
9	1	LA01	A100	Socket assembly	1	0.0	1	
10	2	A100	1500	Steel holder	1	0.0	1	
11	3	1500	1400	1/4-20 Screw	2	0.0	2	
12	2	A100	1600	One-way socket	1	0.0	1	
13	2	A100	1700	Wiring assembly	1	0.0	1	
14	3	1700	2200	16-Gauge lamp cord	12	0.1	12	
15	3	1700	2210	14-Gauge lamp cord	12	0.1	12	
16	3	1700	2300	Standard plug terminal	1	0.0	1	

Obs	Unit	Lead Time	Tot_Lead	LTOff	Tot_Off	SDate	EDate	Prod
1	Each	2	2	.	0	.	.	LA01
2	Each	1	3	0	0	.	.	LA01
3	Each	2	5	0	0	.	.	LA01
4	Inches	3	8	0	0	.	.	LA01
5	Each	3	6	0	0	.	.	LA01
6	Each	2	5	1	1	.	.	LA01
7	Each	1	4	3	3	.	.	LA01
8	Each	2	4	0	0	.	.	LA01
9	Each	1	3	2	2	.	.	LA01
10	Each	2	5	0	2	.	.	LA01
11	Each	1	6	0	2	.	.	LA01
12	Each	2	5	0	2	.	.	LA01
13	Each	1	4	0	2	.	.	LA01
14	Feet	2	6	0	2	.	07APR2001	LA01
15	Feet	2	6	0	2	08APR2001	.	LA01
16	Each	1	5	0	2	.	.	LA01

The summarized parts list, which has been sorted by the `_Part_` variable, is displayed in [Output 1.3.4](#). Comparing it with the summarized parts list displayed in [Output 1.1.3](#) on page 46, you can see the impact of scrap factor on the gross requirement (and hence, the net requirement). Moreover, the summarized parts list data set shown in [Output 1.3.4](#) contains a record for each of the items '2200' and '2210', and the gross requirements of these two items are not affected by the bill of material effectivity dates.

Output 1.3.4. Summarized Parts List (SumBOM3)

ABC Lamp Company							
Summarized Parts List, Period 1							
Part_	Low_Code	Gros_Req	On_Hand	Net_Req	Lead Time	Desc	Unit
1100	2	1.0	0	1.0	2	Finished shaft	Each
1200	2	1.0	0	1.0	3	6-Diameter steel plate	Each
1300	2	1.0	0	1.0	2	Hub	Each
1400	3	6.0	0	6.0	1	1/4-20 Screw	Each
1500	2	1.0	0	1.0	2	Steel holder	Each
1600	2	1.0	0	1.0	2	One-way socket	Each
1700	2	1.0	0	1.0	1	Wiring assembly	Each
2100	3	31.2	0	31.2	3	3/8 Steel tubing	Inches
2200	3	13.2	0	13.2	2	16-Gauge lamp cord	Feet
2210	3	13.2	0	13.2	2	14-Gauge lamp cord	Feet
2300	3	1.0	0	1.0	1	Standard plug terminal	Each
A100	1	1.0	0	1.0	1	Socket assembly	Each
B100	1	1.0	0	1.0	1	Base assembly	Each
LA01	0	1.0	0	1.0	2	Lamp LA	Each
S100	1	1.0	0	1.0	2	Black shade	Each

Example 1.4. Planning Bill of Material

The previous examples dealt with the bill of material from the perspective of the manufacturing process. In this example, let us turn to another type of BOM that is often useful in planning and handling engineering charges. It is referred to as a *planning BOM*, *pseudo BOM*, *super BOM*, or *phantom BOM*.

Assume that the ABC Lamp Company sells lamps with eight different shades (either 14 inches or 15 inches, in the colors black, white, cream, or yellow), three alternate base plates (6 inches, 7 inches, or 8 inches), and two types of sockets ('One-way' and 'Three-way'). Working with all possible combinations, the company now has 48 ($= 8 \times 3 \times 2$) different final products. In other words, the ABC Lamp Company has 48 different end items to forecast and plan. This might not sound too complicated; however, this example is a simplified case. Manufacturing companies producing automobiles, computers, or machine tools can easily make over 5,000 different final products. So many final products are obviously impossible to forecast accurately and plan with any hope of validity. However, a reasonable forecast for total lamp sales could be made, for example, 10,000 per week. Some items (such as '1100 Finished shaft') are common to all configurations. Although these items are produced independently of one another, they can be grouped as common items on the BOM for administrative purposes. The new item that is created to group all common items is never stocked and hence it is called a *phantom item*. Phantom items are generally assigned 0 lead times and lot-for-lot order quantity. Besides the phantom item for grouping common items, other phantom items are created for planning different options. These items are referred to as *model items*. This process is known as the *modularized bill of material construction*.

The following SAS code creates three data sets: The Phantom4 data set contains the generic item 'LAXX' and all phantom items. The data set Option4 lists all options of each model item that are not already in the Part Master data set PMaster3 (shown

in [Output 1.3.1](#) on page 54). Finally, the ParComp4 data set contains the re-grouped product structure information.

```

/* Generic and phantom Part Master data */
data Phantom4;
  format Part $8. Desc $24. Unit $8.;
  input Part & Desc & Req Unit & LeadTime;
datalines;
LAXX    Lamp LA                10000 Each      3
4000    Common parts           . Each        0
A10X    Socket assembly options . Each        0
B10X    Base assembly options  . Each        0
S10X    Shade options          . Each        0
;

/* Additional options and alternative parts */
data Option4;
  format Part $8. Desc $24. Unit $8.;
  input Part & Desc & Req Unit & LeadTime;
datalines;
A101    Three-way socket assem. . Each        1
B101    7in Base assembly      . Each        1
B102    8in Base assembly      . Each        1
S101    14in White shade       . Each        2
S102    14in Cream shade       . Each        2
S103    14in Yellow shade      . Each        2
S104    15in Black shade       . Each        2
S105    15in White shade       . Each        2
S106    15in Cream shade       . Each        2
S107    15in Yellow shade      . Each        2
1201    7-Diameter steel plate  . Each        3
1202    8-Diameter steel plate  . Each        3
1601    Three-way socket       . Each        2
;

```



```

/* Parent-component relationship data */
data ParComp4;
  format Part $8. Component $8. QtyPer 8.2 ;
  input Part $ Component $ QtyPer;
datalines;
LAXX    4000      1.00
LAXX    B10X      1.00
LAXX    S10X      1.00
LAXX    A10X      1.00
4000    1100      1.00
4000    1300      1.00
4000    1400      4.00
4000    1500      1.00
4000    1700      1.00
B10X    B100      0.32
B10X    B101      0.41
B10X    B102      0.33
S10X    S100      0.07
S10X    S101      0.18
S10X    S102      0.24
S10X    S103      0.10
S10X    S104      0.06
S10X    S105      0.14
S10X    S106      0.22
S10X    S107      0.10
A10X    A100      0.11
A10X    A101      0.92
B100    1200      1.00
B101    1201      1.00
B102    1202      1.00
A100    1600      1.00
A101    1601      1.00
1100    2100      26.00
1500    1400      2.00
1700    2200      12.00
1700    2300      1.00
;

```

The item identified as '4000' is the phantom item for common items '1100', '1300', '1400', '1500', and '1700'. Each available option is structured into a model item with a quantity per assembly (identified as the `QtyPer` variable) that represents its forecast popularity or option percentage. Note that the total percentage of each option in this example is more than 100 percent (for example, the total percentage of the 'A10X: Socket assembly options' is $0.11 + 0.92 = 1.03$). This extra percentage is used to cover the uncertainty of the exact percentage split. Using this procedure to cover possible high side demand for each option is called *option overplanning* (Fogarty, Blackstone, and Hoffmann 1991).

The new Part Master data set, PMaster4, combines the generic and phantom item data, the additional options data, and the old Part Master file shown in [Output 1.3.1](#) on page 54. The SAS code to accomplish this is as follows:

```

/* Append the old Part Master data to the new */
/* phantom item and additional option data sets */
data PMaster4;
  set Phantom4
      Option4
      PMaster3(where=(Part NE 'LA01' AND Part NE '2210'));
run;

proc sort data=PMaster4;
  by Part;
run;

```

The following code invokes PROC BOM to generate the planning bill of material and the summarized parts list from the modularized product structure data and the expanded part master file.

```

/* Generate the Indented BOM and Summarized Parts data sets */
proc bom data=ParComp4 pmdata=PMaster4
  out=IndBOM4 summaryout=SumBOM4;
  structure / part=Part
            requirement=Req
            leadtime=LeadTime
            parent=Parent
            component=Component
            quantity=QtyPer
            id=(Desc Unit);
run;

```

The indented bill of material is shown in [Output 1.4.1](#). [Output 1.4.2](#) lists the quantity of each item that is needed to build 10,000 lamps in period 4, sorted by the `_Part_` variable.

Output 1.4.1. Planning Bill of Material with Option Overplanning (IndBOM4)

ABC Lamp Company								
Indented Bill of Material, Part LAXX								
				Q		L	T	
	P			t		e	o	
L	a			Q		a	t	
e	r	P		t		d	P	
v	a	D		y	P	U	T	
e	r	e		P	r	n	L	
l	t	s		e	o	i	r	
		c		r	d	t	e	
							d	
0	LAXX	Lamp LA	.	1.00	Each	3	3	LAXX
1	LAXX	4000 Common parts	1.00	1.00	Each	0	3	LAXX
2	4000	1100 Finished shaft	1.00	1.00	Each	2	5	LAXX
3	1100	2100 3/8 Steel tubing	26.00	26.00	Inches	3	8	LAXX
2	4000	1300 Hub	1.00	1.00	Each	2	5	LAXX
2	4000	1400 1/4-20 Screw	4.00	4.00	Each	1	4	LAXX
2	4000	1500 Steel holder	1.00	1.00	Each	2	5	LAXX
3	1500	1400 1/4-20 Screw	2.00	2.00	Each	1	6	LAXX
2	4000	1700 Wiring assembly	1.00	1.00	Each	1	4	LAXX
3	1700	2200 16-Gauge lamp cord	12.00	12.00	Feet	2	6	LAXX
3	1700	2300 Standard plug terminal	1.00	1.00	Each	1	5	LAXX
1	LAXX	B10X Base assembly options	1.00	1.00	Each	0	3	LAXX
2	B10X	B100 Base assembly	0.32	0.32	Each	1	4	LAXX
3	B100	1200 6-Diameter steel plate	1.00	0.32	Each	3	7	LAXX
2	B10X	B101 7in Base assembly	0.41	0.41	Each	1	4	LAXX
3	B101	1201 7-Diameter steel plate	1.00	0.41	Each	3	7	LAXX
2	B10X	B102 8in Base assembly	0.33	0.33	Each	1	4	LAXX
3	B102	1202 8-Diameter steel plate	1.00	0.33	Each	3	7	LAXX
1	LAXX	S10X Shade options	1.00	1.00	Each	0	3	LAXX
2	S10X	S100 Black shade	0.07	0.07	Each	2	5	LAXX
2	S10X	S101 14in White shade	0.18	0.18	Each	2	5	LAXX
2	S10X	S102 14in Cream shade	0.24	0.24	Each	2	5	LAXX
2	S10X	S103 14in Yellow shade	0.10	0.10	Each	2	5	LAXX
2	S10X	S104 15in Black shade	0.06	0.06	Each	2	5	LAXX
2	S10X	S105 15in White shade	0.14	0.14	Each	2	5	LAXX
2	S10X	S106 15in Cream shade	0.22	0.22	Each	2	5	LAXX
2	S10X	S107 15in Yellow shade	0.10	0.10	Each	2	5	LAXX
1	LAXX	A10X Socket assembly options	1.00	1.00	Each	0	3	LAXX
2	A10X	A100 Socket assembly	0.11	0.11	Each	1	4	LAXX
3	A100	1600 One-way socket	1.00	0.11	Each	2	6	LAXX
2	A10X	A101 Three-way socket assem.	0.92	0.92	Each	1	4	LAXX
3	A101	1601 Three-way socket	1.00	0.92	Each	2	6	LAXX

Output 1.4.2. Summarized Parts List (SumBOM4)

ABC Lamp Company							
Summarized Parts List, Period 4							
<u>Part</u>	<u>Low_Code</u>	<u>Req</u>	<u>On_Hand</u>	<u>Net_Req</u>	<u>Lead</u> <u>Time</u>	<u>Desc</u>	<u>Unit</u>
1100	2	10000	0	10000	2	Finished shaft	Each
1200	3	3200	0	3200	3	6-Diameter steel plate	Each
1201	3	4100	0	4100	3	7-Diameter steel plate	Each
1202	3	3300	0	3300	3	8-Diameter steel plate	Each
1300	2	10000	0	10000	2	Hub	Each
1400	3	60000	0	60000	1	1/4-20 Screw	Each
1500	2	10000	0	10000	2	Steel holder	Each
1600	3	1100	0	1100	2	One-way socket	Each
1601	3	9200	0	9200	2	Three-way socket	Each
1700	2	10000	0	10000	1	Wiring assembly	Each
2100	3	260000	0	260000	3	3/8 Steel tubing	Inches
2200	3	120000	0	120000	2	16-Gauge lamp cord	Feet
2300	3	10000	0	10000	1	Standard plug terminal	Each
4000	1	10000	0	10000	0	Common parts	Each
A100	2	1100	0	1100	1	Socket assembly	Each
A101	2	9200	0	9200	1	Three-way socket assem.	Each
A10X	1	10000	0	10000	0	Socket assembly options	Each
B100	2	3200	0	3200	1	Base assembly	Each
B101	2	4100	0	4100	1	7in Base assembly	Each
B102	2	3300	0	3300	1	8in Base assembly	Each
B10X	1	10000	0	10000	0	Base assembly options	Each
LAXX	0	10000	0	10000	3	Lamp LA	Each
S100	2	700	0	700	2	Black shade	Each
S101	2	1800	0	1800	2	14in White shade	Each
S102	2	2400	0	2400	2	14in Cream shade	Each
S103	2	1000	0	1000	2	14in Yellow shade	Each
S104	2	600	0	600	2	15in Black shade	Each
S105	2	1400	0	1400	2	15in White shade	Each
S106	2	2200	0	2200	2	15in Cream shade	Each
S107	2	1000	0	1000	2	15in Yellow shade	Each
S10X	1	10000	0	10000	0	Shade options	Each

Example 1.5. Modular Bills of Material

The previous example illustrated how the bills of material can be arranged in product modules or options in order to obtain better forecasting, master production scheduling, and planning. There are also a number of other reasons for using *modular bills of material*. One reason is that the task of maintaining modularized bills of material is much simpler. The only bills of material that have to be maintained are the modules; there is no need to maintain enormous numbers of unique product configurations (Landvater and Gray 1989). You can easily construct a bill of material for a particular product configuration from the modular bills of material, if necessary. This example shows how to build modular bills of material for the 48 product configurations as described in [Example 1.4](#) (page 57). It also demonstrates how to construct a final-product-oriented bill of material from the modularized bills of material.

The `ParComp5` data set contains the new product structure information. In this data set, the phantom items `'A10X'`, `'B10X'`, and `'S10X'` are used as place holders for product modules: `'A100'`, `'A101'`, `'B100'`, ..., `'S107'`. The following code first creates the new Product Structure data set, `ParComp5`. It then invokes PROC BOM with the Part Master data set, `PMaster4` (described in [Example 1.4](#) on page 57), and the new Product Structure data set, `ParComp5`, to construct modular bills of material for the production line of the company. It also displays the modularized indented bills of material.

```

/* Product Structure data */
data ParComp5;
  format Parent $8. Component $8. QtyPer 8.2 ;
  input Parent $ Component $ QtyPer;
datalines;
LAXX    4000          1.00
LAXX    B10X         1.00
LAXX    S10X         1.00
LAXX    A10X         1.00
4000    1100          1.00
4000    1300          1.00
4000    1400          4.00
4000    1500          1.00
4000    1700          1.00
B100    1200          1.00
B101    1201          1.00
B102    1202          1.00
A100    1600          1.00
A101    1601          1.00
1100    2100         26.00
1500    1400          2.00
1700    2200         12.00
1700    2300          1.00
;

/* Generate the indented BOM data set */
proc bom data=ParComp5 pmdata=PMaster4 out=IndBOM5;
  structure / part=Part

```

```

leadtime=LeadTime
parent=Parent
component=Component
quantity=QtyPer
id=(Desc Unit);

run;

```

The Indented BOM data set, IndBOM5, is shown in [Output 1.5.1](#). This output data set contains a pseudo bill of material for the pseudo end item 'LAXX' and 13 modules (modular bills of material) for items 'A100', 'A101', 'B100', 'B101', 'B102', and 'S100' ..., 'S107', respectively.

Output 1.5.1. Modularized Indented Bills of Material (IndBOM5)

ABC Lamp Company								
Indented Bills of Material								
Level	Parent	Component	Description	Quantity	Unit	Lead	Time	Parent
—	P	—		Q	U	L	T	—
—	—	—		Y	—	e	o	—
—	—	—		P	—	d	—	P
—	—	—		r	—	T	L	r
—	—	—		e	—	i	e	o
—	—	—		o	—	m	a	d
—	—	—		r	—	e	d	—
—	—	—		d	—	t	—	—
0		A100	Socket assembly	. 1	Each	1	1	A100
1	A100	1600	One-way socket	1 1	Each	2	3	A100
0		A101	Three-way socket assem.	. 1	Each	1	1	A101
1	A101	1601	Three-way socket	1 1	Each	2	3	A101
0		B100	Base assembly	. 1	Each	1	1	B100
1	B100	1200	6-Diameter steel plate	1 1	Each	3	4	B100
0		B101	7in Base assembly	. 1	Each	1	1	B101
1	B101	1201	7-Diameter steel plate	1 1	Each	3	4	B101
0		B102	8in Base assembly	. 1	Each	1	1	B102
1	B102	1202	8-Diameter steel plate	1 1	Each	3	4	B102
0		LAXX	Lamp LA	. 1	Each	3	3	LAXX
1	LAXX	4000	Common parts	1 1	Each	0	3	LAXX
2	4000	1100	Finished shaft	1 1	Each	2	5	LAXX
3	1100	2100	3/8 Steel tubing	26 26	Inches	3	8	LAXX
2	4000	1300	Hub	1 1	Each	2	5	LAXX
2	4000	1400	1/4-20 Screw	4 4	Each	1	4	LAXX
2	4000	1500	Steel holder	1 1	Each	2	5	LAXX
3	1500	1400	1/4-20 Screw	2 2	Each	1	6	LAXX
2	4000	1700	Wiring assembly	1 1	Each	1	4	LAXX
3	1700	2200	16-Gauge lamp cord	12 12	Feet	2	6	LAXX
3	1700	2300	Standard plug terminal	1 1	Each	1	5	LAXX
1	LAXX	B10X	Base assembly options	1 1	Each	0	3	LAXX
1	LAXX	S10X	Shade options	1 1	Each	0	3	LAXX
1	LAXX	A10X	Socket assembly options	1 1	Each	0	3	LAXX
0		S100	Black shade	. 1	Each	2	2	S100
0		S101	14in White shade	. 1	Each	2	2	S101
0		S102	14in Cream shade	. 1	Each	2	2	S102
0		S103	14in Yellow shade	. 1	Each	2	2	S103
0		S104	15in Black shade	. 1	Each	2	2	S104
0		S105	15in White shade	. 1	Each	2	2	S105
0		S106	15in Cream shade	. 1	Each	2	2	S106
0		S107	15in Yellow shade	. 1	Each	2	2	S107

The following SAS code constructs an indented bill of material for the product 'LA01', which is configured with 'A100' (One-way socket assembly),

'B100' (6in Base assembly), and 'S100' (14in Black shade). It first uses the %BOMTSAE SAS macro to create a bill of material that is the same as the bill for the item 'LAXX', except the pseudo item 'B10X' is replaced by the modular bill for the item 'B100'. It then uses the %BOMTREP SAS macro to replace the pseudo items 'S10X' and 'A10X' with the bills of material for 'S100' and 'A100'. Note that the %BOMTSAE macro refers to the part master file PMaster3 (shown in [Output 1.3.1](#) on page 54) for the master data of the item 'LA01'. See the “[Transactional Macros](#)” section beginning on page 111 for details on these SAS macros.

```

/* Copy LAXX to LA01 with B10X replaced by B100 */
%bomtsae(root='LA01', sameas='LAXX', except='B10X', repby='B100',
         in=IndBOM5, pmdata=PMaster3, part=Part, quantity=QtyPer,
         leadtime=LeadTime, id=Desc Unit, out=BomOut5);

/* Merge the bill of material for S100 to the new BOM */
data BomOut51;
  set BomOut5
    IndBOM5(where=( _Prod_='S100' ));
run;

/* Replace S10X with S100 */
%bomtrep(root='S10X', repby='S100', in=BomOut51, quantity=QtyPer,
         leadtime=LeadTime, id=Desc Unit, del=1, out=BomOut52);

/* Merge the bill of material for A100 to the new BOM */
data BomOut53;
  set BomOut52
    IndBOM5(where=( _Prod_='A100' ));
run;

/* Replace A10X with A100 */
%bomtrep(root='A10X', repby='A100', in=BomOut53, quantity=QtyPer,
         leadtime=LeadTime, id=Desc Unit, del=1, out=BomOut5);

```

The indented bill of material for item 'LA01' is displayed in [Output 1.5.2](#). It is the same as the bill of material displayed in [Output 1.2.2](#) on page 50 (which is created directly by PROC BOM), except for the common items such as '1100', '1300', '1400', '1500', and '1700', which are regrouped under the phantom item '4000'.

Output 1.5.2. Indented Bill of Material for Product 'LA01' (BomOut5)

ABC Lamp Company									
Indented Bill of Material, Part LA01									
Q	L	T							
t	e	o							
Q	Y	a	t	P	U	T	L	P	
y	P	r	n	i	e	o	d		
P	r	n	i	e	o	d			
e	o	i	m	a	d				
r	d	t	e	d					
0		LA01	Lamp LA	.	1	Each	2	2	LA01
1	LA01	4000	Common parts	1	1	Each	0	2	LA01
2	4000	1100	Finished shaft	1	1	Each	2	4	LA01
3	1100	2100	3/8 Steel tubing	26	26	Inches	3	7	LA01
2	4000	1300	Hub	1	1	Each	2	4	LA01
2	4000	1400	1/4-20 Screw	4	4	Each	1	3	LA01
2	4000	1500	Steel holder	1	1	Each	2	4	LA01
3	1500	1400	1/4-20 Screw	2	2	Each	1	5	LA01
2	4000	1700	Wiring assembly	1	1	Each	1	3	LA01
3	1700	2200	16-Gauge lamp cord	12	12	Feet	2	5	LA01
3	1700	2300	Standard plug terminal	1	1	Each	1	4	LA01
1	LA01	A100	Socket assembly	1	1	Each	1	3	LA01
2	A100	1600	One-way socket	1	1	Each	2	5	LA01
1	LA01	B100	Base assembly	1	1	Each	1	3	LA01
2	B100	1200	6-Diameter steel plate	1	1	Each	3	6	LA01
1	LA01	S100	Black shade	1	1	Each	2	4	LA01

Example 1.6. Bills of Material with Repeated Relationships

As briefly described in the “Product Structure Data Set” section beginning on page 32, sometimes it is necessary to structure a given component into a parent item more than once because it is used at different places, at different times in the process, or in different operations. The Product Structure data set shown in [Output 1.6.1](#) is an example of this situation. Because of the different points of use (denoted by the *PointUse* variable) and lead-time offsets (denoted by the *LTOff* variable) involved in its two relationships, item '1400' (1/4-20 Screw) cannot be structured just once into the parent item 'B100' (Base assembly). The *Line* variable in this data set denotes the *line sequence number*, which is part of the unique *key* in the product structure record. Although it is not necessary in the BOM procedure, some software packages will not allow two relationships with the same parent and component. However, when unique line sequence numbers are assigned, a given component can be structured into a parent item any number of times. Line sequence numbers are sometimes used to sequence components in the desired order on a bill of material, frequently in order of use. They are also used on occasion to refer to the *balloon* or *find* number on engineer drawings (Clement, Coldrick, and Sari 1992).

Output 1.6.1. Product Structure Data Set with Repeated Relationships

ABC Lamp Company						
Product Structure Records						
Parent	Component	Qty Per	Fscrap	Line	Point Use	LTOff
LA01	B100	1	.	010	SA2	0
	S100	1	.	015	SA2	0
	A100	1	.	020	SA5	15
B100	1100	1	.	010	SA4A	0
	1200	1	.	020	SA4A	0
	1400	4	0.25	110	SA4A	0
	1300	1	.	120	SA4B	20
	1400	4	0.50	215	SA4B	20
A100	1500	1	.	100	SA3	0
	1600	1	.	110	SA3	0
	1700	1	.	120	SA5	0
1100	2100	26	0.20		SA9B	0
1500	1400	2	.		SA7	0
1700	2200	12	0.10	010	SA5	0
	2300	1	.	030	SA5	5

The following code invokes PROC BOM with this Product Structure data set, ParComp6, and the Part Master data set, PMaster3 (shown in Output 1.3.1 on page 54), to create the indented bill of material for the product 'LA01'. The Line and PointUse variables specified in the RID= option can be used to distinguish the two relationships with the same parent item 'B100' and components '1400' (observations 6 and 8) in the indented BOM data set as displayed in Output 1.6.2.

```

/* Create the indented BOM */
proc bom data=ParComp6 pmdata=PMaster3 out=IndBOM6a;
  structure / part=Part
             leadtime=LeadTime
             parent=Parent
             component=Component
             quantity=QtyPer
             factor=Fscrap
             offset=LTOff
             id=(Desc Unit)
             rid=(Line PointUse)
             enditem=("LA01");
run;

```

Output 1.6.2. Indented Bill of Material with Repeated Relationships

ABC Lamp Company															
Indented Bill of Material, Part LA01															
Q	F	Y	U	L	T	T	L	T	P	o					
t	s	—	P	d	—	—	—	—	o	—					
y	c	P	U	T	L	T	—	L	t	r					
P	r	r	n	i	O	O	i	U	o	—					
e	a	o	i	m	a	f	f	n	s	d					
r	p	d	t	e	d	f	f	e	e	—					
1	.	.	1	Each	2	2	.	0		LA01					
2	1	LA01	B100	Base assembly	1	0.00	1	Each	1	3	0	0	010	SA2	LA01
3	2	B100	1100	Finished shaft	1	0.00	1	Each	2	5	0	0	010	SA4A	LA01
4	3	1100	2100	3/8 Steel tubing	26	0.20	26	Inches	3	8	0	0		SA9B	LA01
5	2	B100	1200	6-Diameter steel plate	1	0.00	1	Each	3	6	0	0	020	SA4A	LA01
6	2	B100	1400	1/4-20 Screw	4	0.25	4	Each	1	4	0	0	110	SA4A	LA01
7	2	B100	1300	Hub	1	0.00	1	Each	2	5	20	20	120	SA4B	LA01
8	2	B100	1400	1/4-20 Screw	4	0.50	4	Each	1	4	20	20	215	SA4B	LA01
9	1	LA01	S100	Black shade	1	0.00	1	Each	2	4	0	0	015	SA2	LA01
10	1	LA01	A100	Socket assembly	1	0.00	1	Each	1	3	15	15	020	SA5	LA01
11	2	A100	1500	Steel holder	1	0.00	1	Each	2	5	0	15	100	SA3	LA01
12	3	1500	1400	1/4-20 Screw	2	0.00	2	Each	1	6	0	15		SA7	LA01
13	2	A100	1600	One-way socket	1	0.00	1	Each	2	5	0	15	110	SA3	LA01
14	2	A100	1700	Wiring assembly	1	0.00	1	Each	1	4	0	15	120	SA5	LA01
15	3	1700	2200	16-Gauge lamp cord	12	0.10	12	Feet	2	6	0	15	010	SA5	LA01
16	3	1700	2300	Standard plug terminal	1	0.00	1	Each	1	5	5	20	030	SA5	LA01

The BOM procedure can create bills of material with two or more identical relationships in a given parent item, if necessary. The specification of the keyword `KEEP` for the `DUPLICATE=` option tells PROC BOM to sequence components in the same order as they are listed in the Product Structure data set while constructing the indented bills of material. The following SAS code invokes PROC BOM to create a bill of material with identical relationships, displayed in [Output 1.6.3](#). Note that the `RID=` option is not specified in this invocation of PROC BOM: the two relationships with the same parent item 'B100' and component '1400' are identical.

```

/* Create the indented BOM */
proc bom data=ParComp6 pmdata=PMaster3 out=IndBOM6b
    duplicate=KEEP;
    structure / part=Part
        leadtime=LeadTime
        parent=Parent
        component=Component
        quantity=QtyPer
        factor=Fscrap
        id=(Desc Unit)
        enditem=("LA01");
run;

```

Output 1.6.3. Indented Bill of Material with Identical Relationships

ABC Lamp Company										
Indented Bill of Material, Part LA01										
Q	F	Y	L	T						
Quantity	Factor	Unit	Parent	Component	Description	Order	Time	Part	Level	
0			LA01		Lamp LA	.	.	1	Each	2 2 LA01
1	0.00		LA01	B100	Base assembly	1	0.00	1	Each	1 3 LA01
2	0.00		B100	1100	Finished shaft	1	0.00	1	Each	2 5 LA01
3	0.20	26	1100	2100	3/8 Steel tubing	26	0.20	26	Inches	3 8 LA01
2	0.00		B100	1200	6-Diameter steel plate	1	0.00	1	Each	3 6 LA01
2	0.25		B100	1400	1/4-20 Screw	4	0.25	4	Each	1 4 LA01
2	0.00		B100	1300	Hub	1	0.00	1	Each	2 5 LA01
2	0.50		B100	1400	1/4-20 Screw	4	0.50	4	Each	1 4 LA01
1	0.00		LA01	S100	Black shade	1	0.00	1	Each	2 4 LA01
1	0.00		LA01	A100	Socket assembly	1	0.00	1	Each	1 3 LA01
2	0.00		A100	1500	Steel holder	1	0.00	1	Each	2 5 LA01
3	0.00		1500	1400	1/4-20 Screw	2	0.00	2	Each	1 6 LA01
2	0.00		A100	1600	One-way socket	1	0.00	1	Each	2 5 LA01
2	0.00		A100	1700	Wiring assembly	1	0.00	1	Each	1 4 LA01
3	0.10	12	1700	2200	16-Gauge lamp cord	12	0.10	12	Feet	2 6 LA01
3	0.00		1700	2300	Standard plug terminal	1	0.00	1	Each	1 5 LA01

On other occasions, you may want the bills of material to show the total quantity of each component used by a given parent item without any reference to the order, time, or place of use. To do this, you can specify the keyword *COMBINE* for the *DUPLICATE=* option. This is the default behavior of the *DUPLICATE=* option. The SAS code to accomplish this is as follows:

```

/* Create the indented BOM */
proc bom data=ParComp6 pmdata=PMaster3 out=IndBOM6c
    duplicate=COMBINE;
    structure / part=Part
        leadtime=LeadTime
        parent=Parent
        component=Component
        quantity=QtyPer
        factor=Fscrap
        id=(Desc Unit)
        enditem=("LA01");
run;

```

The indented bill of material is displayed in [Output 1.6.4](#). Note that the two identical relationships of the parent 'B100' and the component '1400' are collapsed into one relationship. See the "Product Structure Data Set" section beginning on page 32 for details on combining identical parent-component relationships.

Output 1.6.4. Indented Bill of Material with Identical Relationships Collapsed

ABC Lamp Company									
Indented Bill of Material, Part LA01									
Q	U	Q	F	Y	L	T			
ty	pc	pr	rn	ia	o	i	ma	d	
er	pa	ds	ed						
0		LA01	Lamp LA	.	.	1	Each	2 2	LA01
1	LA01	B100	Base assembly	1	0.000	1	Each	1 3	LA01
2	B100	1100	Finished shaft	1	0.000	1	Each	2 5	LA01
3	1100	2100	3/8 Steel tubing	26	0.200	26	Inches	3 8	LA01
2	B100	1200	6-Diameter steel plate	1	0.000	1	Each	3 6	LA01
2	B100	1400	1/4-20 Screw	8	0.375	8	Each	1 4	LA01
2	B100	1300	Hub	1	0.000	1	Each	2 5	LA01
1	LA01	S100	Black shade	1	0.000	1	Each	2 4	LA01
1	LA01	A100	Socket assembly	1	0.000	1	Each	1 3	LA01
2	A100	1500	Steel holder	1	0.000	1	Each	2 5	LA01
3	1500	1400	1/4-20 Screw	2	0.000	2	Each	1 6	LA01
2	A100	1600	One-way socket	1	0.000	1	Each	2 5	LA01
2	A100	1700	Wiring assembly	1	0.000	1	Each	1 4	LA01
3	1700	2200	16-Gauge lamp cord	12	0.100	12	Feet	2 6	LA01
3	1700	2300	Standard plug terminal	1	0.000	1	Each	1 5	LA01

Example 1.7. Bills of Material Verification

The previous examples illustrated how companies may have more than one type of bill of material. It is important that while the different types of BOM may differ in the way items are grouped together, they must use the same components (except the phantom items) in the same quantities, or require the same amount of materials in order to fill the same production plan. This example demonstrates some simple methods that compare the different types of BOM and detect any differences.

One way to compare two bills of material is to compare their summarized parts lists for the same production plan. The following SAS code creates a transactional data set, `Trans7`, which contains the new values of the gross requirements for the lamp `'LAXX'` and all base assembly, shade, or socket assembly options that are described in [Example 1.4](#) on page 57. The gross requirements for the lamp `'LAXX'` and options `'B100'`, `'S100'`, and `'A100'` that are associated with the lamp `'LA01'` are 1. All other options have 0 gross requirement. Therefore, the item `'LAXX'` and all of the options listed in the data set `Trans7` are master schedule items. See the [“Part Master Data Set”](#) section beginning on page 30 for a detailed description about master schedule items.

```

/* Gross requirement transactional data set */
data Trans7;
  format Part $8. Req 8.0 ;
  input Part $ Req ;
datalines;
LAXX          1
B100          1
B101          0
B102          0
S100          1
S101          0
S102          0
S103          0
S104          0
S105          0
S106          0
S107          0
A100          1
A101          0
;

```

The following SAS DATA step code updates the value of the Req variable in the PMaster4 data set (described in [Example 1.4](#) on page 57) with the value of the variable in the transactional data set Trans7.

```

proc sort data=Trans7;
  by Part;
run;

/* Update the gross requirement values of the */
/* Product Structure data set */
data PMaster7(drop=OldReq);
  merge PMaster4(rename=(Req=OldReq)) Trans7(in=in2);
  by Part;

  if not in2 then Req=OldReq;
run;

```

The following code invokes PROC BOM with the new Part Master data set PMaster7 and the Product Structure data set ParComp4 (described in [Example 1.4](#) on page 57). The summarized parts list is shown in [Output 1.7.1](#).

```

/* Generate the indented BOM and summarized parts list */
proc bom data=ParComp4 pmdata=PMaster7
  out=IndBOM7 summaryout=SumBOM7;
  structure / part=Part
    requirement=Req
    leadtime=LeadTime
    parent=Parent
    component=Component
    quantity=QtyPer
    id=(Desc Unit);
run;

```

Output 1.7.1. Summarized Parts List (SumBOM7)

ABC Lamp Company							
Summarized Parts List, Period 1							
<u>Part_</u>	<u>Low_Code</u>	<u>Req</u>	<u>On_Hand</u>	<u>Net_Req</u>	<u>Lead Time</u>	<u>Desc</u>	<u>Unit</u>
1100	2	1	0	1	2	Finished shaft	Each
1200	3	1	0	1	3	6-Diameter steel plate	Each
1300	2	1	0	1	2	Hub	Each
1400	3	6	0	6	1	1/4-20 Screw	Each
1500	2	1	0	1	2	Steel holder	Each
1600	3	1	0	1	2	One-way socket	Each
1700	2	1	0	1	1	Wiring assembly	Each
2100	3	26	0	26	3	3/8 Steel tubing	Inches
2200	3	12	0	12	2	16-Gauge lamp cord	Feet
2300	3	1	0	1	1	Standard plug terminal	Each
4000	1	1	0	1	0	Common parts	Each
A100	2	1	0	1	1	Socket assembly	Each
A10X	1	1	0	1	0	Socket assembly options	Each
B100	2	1	0	1	1	Base assembly	Each
B10X	1	1	0	1	0	Base assembly options	Each
LAXX	0	1	0	1	3	Lamp LA	Each
S100	2	1	0	1	2	Black shade	Each
S10X	1	1	0	1	0	Shade options	Each

The summarized parts list in [Output 1.7.1](#) and the one in [Output 1.1.3](#) on page 46 are in agreement in the values of gross and net requirements, except for those phantom items, such as '4000 Common parts', 'A10X Socket assembly options', 'B10X Base assembly options', and 'S10X Shade options', which are not listed in [Output 1.1.3](#).

Another way to compare two bills of material is to compare their summarized bills of material. Recall that, as discussed in [Example 1.1](#), the summarized parts list as displayed in [Output 1.1.3](#) on page 46 is also the summarized bill of material for the item 'LA01'. You can also use the %BOMRSUB SAS macro described in [Chapter 2](#), "Bill-of-Material Post-Processing Macros," or the SAS DATA step to create the summarized bill of material from an indented bill of material. See [Example 1.9](#) on page 76 for an example of using a SAS DATA step to create a summarized bill of material from the [Indented BOM](#) data set.

The following SAS code uses the %BOMRSUB macro to create a summarized bill of material for the item 'LA01' from the Indented BOM data set shown in [Output](#)

1.5.2 on page 66. The “qtyreq=Gros_Req” specification indicates that the total requirement for the item identified by the `_Part_` variable should be stored in the `Gros_Req` variable.

```
/* Create the summarized bill of material */
%bomrsub(root='LA01', in=BomOut5, quantity=QtyPer,
         qtyreq=Gros_Req, out=BomOut7);
```

Output 1.7.2. Summarized Bills of Material (BomOut7)

ABC Lamp Company			
Summarized Bill of Material, Part LA01			
<code>_Part_</code>	<code>Gros_Req</code>	<code>Desc</code>	<code>Unit</code>
1100	1	Finished shaft	Each
1200	1	6-Diameter steel plate	Each
1300	1	Hub	Each
1400	6	1/4-20 Screw	Each
1500	1	Steel holder	Each
1600	1	One-way socket	Each
1700	1	Wiring assembly	Each
2100	26	3/8 Steel tubing	Inches
2200	12	16-Gauge lamp cord	Feet
2300	1	Standard plug terminal	Each
4000	1	Common parts	Each
A100	1	Socket assembly	Each
B100	1	Base assembly	Each
S100	1	Black shade	Each

Again, the summarized bill of material, shown in [Output 1.7.2](#), agrees with the summarized bill of material displayed in [Output 1.1.3](#) on page 46 in the values of gross requirements, except for the phantom items ‘4000 Common parts’. Note also that the gross requirement of the finished good ‘LA01’ is not listed in [Output 1.7.2](#).

Example 1.8. Roll-Up Cost in Indented Bill of Material

As mentioned in the “[Bill of Material Explosion and Implosion](#)” section beginning on page 38, the presence of the `_Level_` variable and the order of the observations in the [Indented BOM](#) data set enables easy bill of material explosion and implosion. This example demonstrates how to calculate the costs for upper-level items using the SAS DATA step.

Suppose the ABC Lamp Company wishes to calculate the cost of the lamp ‘LA01’ based on the costs of purchased items that are at the “leaf” nodes of the BOM family tree. The Indented BOM data set can be used to aggregate values assigned at the “leaf” nodes, up the BOM family tree to calculate the value at the root node, or the final product ‘LA01’.

In the following SAS code, the data set `PMaster8` extends the part master file as displayed in [Figure 1.1](#) on page 19 to contain the cost for purchased items. PROC BOM is invoked with this Part Master data set and the Product Structure data set,

ParComp0 as displayed in [Figure 1.2](#) (page 19) to create the Indented BOM data set, IndBOM8.

```

/* Part master records */
data PMaster8;
  format Part $8. Desc $24. Unit $8. Cost 8.2 ;
  input Part $ Desc & Unit $ Cost;
  datalines;
1100    Finished shaft          Each          .
1200    6-Diameter steel plate Each          9.25
1300    Hub                     Each          5.00
1400    1/4-20 Screw            Each          0.20
1500    Steel holder            Each          .
1600    One-way socket          Each          3.50
1700    Wiring assembly         Each          .
2100    3/8 Steel tubing         Inches         0.05
2200    16-Gauge lamp cord      Feet           0.35
2300    Standard plug terminal  Each          0.50
A100    Socket assembly         Each          .
B100    Base assembly           Each          .
LA01    Lamp LA                 Each          .
S100    Black shade             Each          4.10
;

/* Create the indented BOM */
proc bom pmdata=PMaster8 data=ParComp0 out=IndBOM8;
  structure / part=Part
            parent=Parent
            component=Component
            quantity=QtyPer
            id=(Desc Unit Cost);
run;

```

The following code first reverses the order of the observations in the Indented BOM data set, and then determines the costs for the upper-level items. Afterward, the order of the observations is restored to the original order. The indented bill of material with cost information is displayed in [Output 1.8.1](#). In each observation, the variable `Cost` contains the cost for the item identified by the value of the `_Part_` variable.

```

/* Sort the indented BOM in reverse order */
proc sort data=IndBOM8(drop=_Prod_ Paren_ID);
  by descending Part_ID;
run;

```



```

/* Roll up material cost */
data IndBOM8a;
  set IndBOM8;
  array costs[4] cost1 cost2 cost3 cost4;
  retain cost1 cost2 cost3 cost4 0;
  drop cost1 cost2 cost3 cost4;

/* Determine the cost for the current item */
if Cost=. then Cost=0;
Cost = Cost + costs[_Level_+1];

/* Roll up cost to the upper-level item */
if _Level_ > 0 then
  costs[_Level_]=costs[_Level_]+(QtyPer*Cost);

/* Reset roll up cost for the current level */
costs[_Level_+1]=0;

output;
run;

/* Sort the indented BOM back to the original order */
proc sort data=IndBOM8a;
  by Part_ID;
run;

```

Output 1.8.1. Indented Bills of Material with Roll-Up Cost (IndBOM8a)

ABC Lamp Company							
Indented Bill of Material, Part LA01							
Level	_Parent_	_Part_	Desc	Qty Per	Qty_Prod	Unit	Cost
0		LA01	Lamp LA	.	1	Each	29.05
1	LA01	B100	Base assembly	1	1	Each	16.35
2	B100	1100	Finished shaft	1	1	Each	1.30
3	1100	2100	3/8 Steel tubing	26	26	Inches	0.05
2	B100	1200	6-Diameter steel plate	1	1	Each	9.25
2	B100	1300	Hub	1	1	Each	5.00
2	B100	1400	1/4-20 Screw	4	4	Each	0.20
1	LA01	S100	Black shade	1	1	Each	4.10
1	LA01	A100	Socket assembly	1	1	Each	8.60
2	A100	1500	Steel holder	1	1	Each	0.40
3	1500	1400	1/4-20 Screw	2	2	Each	0.20
2	A100	1600	One-way socket	1	1	Each	3.50
2	A100	1700	Wiring assembly	1	1	Each	4.70
3	1700	2200	16-Gauge lamp cord	12	12	Feet	0.35
3	1700	2300	Standard plug terminal	1	1	Each	0.50

Example 1.9. Bill of Material Explosion

Example 1.8 illustrated using the [Indented BOM](#) data set to roll up costs assigned at the leaf nodes of the BOM family tree to obtain the cost of the final product. Similarly, the same data set can also be used to “explode” (or “propagate”) requirements along the tree, based on requirements specified for the root nodes. The “explosion” can be performed with or without taking into account the quantities on hand or the scrap factors. This example demonstrates a few of these explosions.

Note that the BOM procedure automatically performs the requirement explosion in the calculation of the gross and net requirements of each item when producing the summarized parts list. In the [Summarized Parts](#) data set produced by PROC BOM, the gross and net requirements are calculated taking into account both the quantities on hand and the scrap factors. See the “[Summarized Parts Data Set](#)” section beginning on page 40 for details on calculating the gross and net requirements for each item.

The following SAS code uses the data set `SIBOM2` (displayed in [Output 1.2.1](#) on page 49) with additional specifications of scrap factors (20 percent for the relationship between the parent item ‘1100’ and its component ‘2100’, and 10 percent for the relationship of the component ‘2200’ and its parent ‘1700’) to produce the indented bill of material for ‘LA01’ and the summarized parts list for the requirement of 50 units of item ‘LA01’. The indented BOM, `IndBOM9`, is shown in [Output 1.9.1](#), and the summarized parts list, `SumBOM9`, is shown in [Output 1.9.2](#).

```

/* Product structure and part master data */
data SlBOM9;
  set SlBOM2(drop=LeadTime);

  /* Specify scrap factors for 2100 and 2200 */
  if (Component="2100" and Parent="1100") then Scrap=0.2;
  else if (Component="2200" and Parent="1700") then Scrap=0.1;
run;

/* Create the indented BOM and the summarized parts list */
proc bom data=SlBOM9 out=IndBOM9 summaryout=SumBOM9;
  structure / part=Component
             parent=Parent
             component=Component
             quantity=QtyPer
             id=(Desc Unit)
             requirement=Gros_Req
             qtyonhand=On_Hand
             factor=Scrap;
run;

```

Output 1.9.1. Indented Bill of Material for 'LA01'

ABC Lamp Company							
Indented Bill of Material, Part LA01							
Level	Parent	Part	Desc	Qty Per	Qty Prod	Unit	Scrap
0		LA01	Lamp LA	.	1	Each	.
1	LA01	B100	Base assembly	1	1	Each	0.0
2	B100	1100	Finished shaft	1	1	Each	0.0
3	1100	2100	3/8 Steel tubing	26	26	Inches	0.2
2	B100	1200	6-Diameter steel plate	1	1	Each	0.0
2	B100	1300	Hub	1	1	Each	0.0
2	B100	1400	1/4-20 Screw	4	4	Each	0.0
1	LA01	S100	Black shade	1	1	Each	0.0
1	LA01	A100	Socket assembly	1	1	Each	0.0
2	A100	1500	Steel holder	1	1	Each	0.0
3	1500	1400	1/4-20 Screw	2	2	Each	0.0
2	A100	1600	One-way socket	1	1	Each	0.0
2	A100	1700	Wiring assembly	1	1	Each	0.0
3	1700	2200	16-Gauge lamp cord	12	12	Feet	0.1
3	1700	2300	Standard plug terminal	1	1	Each	0.0

Output 1.9.2. Item Requirements for a Planned Order of 50 Units of 'LA01'

ABC Lamp Company							
Summarized Parts List, Part LA01: Requirement=50							
Part	Low_Code	Gros_Req	On_Hand	Net_Req	Desc	Unit	
1100	2	0	0	0	Finished shaft	Each	
1200	2	0	0	0	6-Diameter steel plate	Each	
1300	2	0	0	0	Hub	Each	
1400	3	60	0	60	1/4-20 Screw	Each	
1500	2	30	0	30	Steel holder	Each	
1600	2	30	0	30	One-way socket	Each	
1700	2	30	0	30	Wiring assembly	Each	
2100	3	0	0	0	3/8 Steel tubing	Inches	
2200	3	396	0	396	16-Gauge lamp cord	Feet	
2300	3	30	0	30	Standard plug terminal	Each	
A100	1	30	0	30	Socket assembly	Each	
B100	1	30	50	0	Base assembly	Each	
LA01	0	50	20	30	Lamp LA	Each	
S100	1	30	0	30	Black shade	Each	

The summarized parts list displayed in [Output 1.9.2](#) lists all items and their quantities required to be made or ordered in order to fill the requirement of 50 units for 'LA01'. The requirements in this list are calculated taking into account each item's quantity on hand and each relationship's scrap factor. However, if you want to analyze how future orders for end items will impact inventory levels, a *gross requirements report* that lists all items and their total requirements to make the pre-specified amount of end items, without any regard for quantities on hand, will be helpful. The gross requirements report can be determined by a top-down calculation through indented bills of material, taking into account only the scrap factors. In other words, once you have an [Indented BOM](#) data set available, you can use it to calculate the gross requirements report for any specified quantity of any end item, as shown below. It is not necessary to invoke the BOM procedure for each value.

The following code performs the top-down calculation, as discussed above, through the Indented BOM data set as displayed in [Output 1.9.1](#) to produce a gross requirements report for an additional order of 50 units of 'LA01'. The gross requirements report, SumReq9, is displayed in [Output 1.9.3](#); this data set has been sorted by the `_Part_` variable.

```

/* Explode the gross requirement to low-level components */
data IndBOM9a;
  set IndBOM9;
  array reqs[4] req1 req2 req3 req4;
  retain req1 req2 req3 req4 0;
  drop req1 req2 req3 req4;

  /* Calculate the gross requirement */
  if _Level_=0 then Req=50;
  else Req=reqs[_Level_]*QtyPer*(1.0+Scrap);

  /* keep the requirement of the current level */
  reqs[_Level_+1]=Req;

  output;
run;

/* Calculate the total requirement for each item */
proc sql;
  create table SumReq9 as
    select _Part_, Desc, Unit,
           sum(Req) as Gros_Req
    from IndBOM9a
    group by _Part_, Desc, Unit;
quit;

```

Output 1.9.3. Total Requirements for Ordering 50 Units of 'LA01'

ABC Lamp Company			
Gross Requirements Report, Part LA01: Requirement=50			
<code>_Part_</code>	<code>Desc</code>	<code>Unit</code>	<code>Gros_Req</code>
1100	Finished shaft	Each	50
1200	6-Diameter steel plate	Each	50
1300	Hub	Each	50
1400	1/4-20 Screw	Each	300
1500	Steel holder	Each	50
1600	One-way socket	Each	50
1700	Wiring assembly	Each	50
2100	3/8 Steel tubing	Inches	1560
2200	16-Gauge lamp cord	Feet	660
2300	Standard plug terminal	Each	50
A100	Socket assembly	Each	50
B100	Base assembly	Each	50
LA01	Lamp LA	Each	50
S100	Black shade	Each	50

In another situation, you may like to know the quantity of each component used in making a certain amount of the end item, without any regard for items on hand and scrap factors. A similar calculation as described above can be used to determine the total usage for each item. In fact, the quantities of lower-level components that are used to make 1 unit of the end item are already contained in the variable `Qty_Prod` of the [Indented BOM](#) data set. You only need to multiply those quantities by the specified amount of the end item and then add the values for the same item together for each one. The following codes performs this task to create a report of the total usage for each item in making 50 units of 'LA01'. This usage report, `SumUse9`, has been sorted by the `_Part_` variable and is shown in [Output 1.9.4](#).

```

/* Calculate the total usage for each item */
proc sql;
  create table SumUse9 as
    select _Part_, Desc, Unit,
           sum(Qty_Prod * 50) as Qty_Use
    from IndBOM9
    group by _Part_, Desc, Unit;
quit;

```

Output 1.9.4. Total Usages for Making 50 Units of 'LA01'

ABC Lamp Company			
Summarized Bill of Material, Part LA01: Requirement=50			
<code>_Part_</code>	Desc	Unit	<code>Qty_Use</code>
1100	Finished shaft	Each	50
1200	6-Diameter steel plate	Each	50
1300	Hub	Each	50
1400	1/4-20 Screw	Each	300
1500	Steel holder	Each	50
1600	One-way socket	Each	50
1700	Wiring assembly	Each	50
2100	3/8 Steel tubing	Inches	1300
2200	16-Gauge lamp cord	Feet	600
2300	Standard plug terminal	Each	50
A100	Socket assembly	Each	50
B100	Base assembly	Each	50
LA01	Lamp LA	Each	50
S100	Black shade	Each	50

As discussed in [Example 1.7](#) on page 70, you can also use the `%BOMRSUB` SAS macro described in [Chapter 2](#), “[Bill-of-Material Post-Processing Macros](#),” to create the same report as that shown in [Output 1.9.4](#).

Example 1.10. Aggregating Forecasts Using PROC BOM

In this example, the BOM procedure is used in a nonstandard application. Recall that the input data for the procedure requires items that are related in a parent-child hierarchy. The procedure uses this information to create an output data set that lists the items in a top-down order that can be used to aggregate information in a variety of ways. Suppose, for example, that the ABC Lamp Company has forecasts that are

available for lamps to be stocked at various stores. The stores are served by warehouses that are, in turn, served by distribution centers. In other words, the different units of business are organized as a “tree.” If the company wishes to aggregate the forecasts to calculate the overall forecast at the distribution center, it can do so using the BOM procedure as follows.

```

/* The input data set */
data demand10;
  format parent $14. child $12. code $2. ;
  input parent & child & code $ pct nitems;
  datalines;
Dist.Center 1      Warehouse 1      DC      1      .
Dist.Center 1      Warehouse 2      DC      1      .
Dist.Center 2      Warehouse 3      DC      1      .
Dist.Center 2      Warehouse 4      DC      1      .
Dist.Center 2      Warehouse 5      DC      1      .
Warehouse 1      Store 01          WH      1      .
Warehouse 1      Store 02          WH      1      .
Warehouse 1      Store 03          WH      1      .
Warehouse 2      Store 04          WH      1      .
Warehouse 2      Store 05          WH      1      .
Warehouse 3      Store 06          WH      1      .
Warehouse 3      Store 07          WH      1      .
Warehouse 3      Store 08          WH      1      .
Warehouse 4      Store 09          WH      1      .
Warehouse 4      Store 10          WH      .5      .
Warehouse 5      Store 11          WH      1      .
Warehouse 5      Store 10          WH      .5      .
Store 01          .                ST      .      10
Store 02          .                ST      .      20
Store 03          .                ST      .      10
Store 04          .                ST      .      20
Store 05          .                ST      .      10
Store 06          .                ST      .      20
Store 07          .                ST      .      10
Store 08          .                ST      .      20
Store 09          .                ST      .      10
Store 10          .                ST      .      20
Store 11          .                ST      .      10
;

```

The data set `demand10` defines the parent-child relationships of the company’s business units. It also specifies the forecasts, via the `nitems` variable, for each store. The `code` variable specifies the type of the business unit identified by the `parent` variable: ‘DC’ for distribution center, ‘WH’ for warehouse, and ‘ST’ for store. Note that some business units may be stocked from more than one parent unit. The `pct` variable specifies the percentage of the items in the unit identified by the `child` variable that are from the parent unit. For example, ‘Store 10’ is stocked evenly (50 percent each) from ‘Warehouse 4’ and ‘Warehouse 5’.

The following code constructs the hierarchical structure of the ABC Lamp Company and aggregates the forecasts for stores up to each distribution center. The aggregated

forecasts for stores, warehouses, and distribution centers are displayed in [Output 1.10.1](#), [Output 1.10.2](#), and [Output 1.10.3](#), respectively.

```

    /* Create the hierarchy structure */
proc bom data=demand10 out=indbom10;
    structure / part=parent
               parent=parent
               component=child
               quantity=pct
               id=(nitems code);
run;

    /* Sort the output data set in reverse order */
proc sort data=indbom10;
    by descending part_id;
run;

    /* Aggregate forecasts through the hierarchy structure */
data accumulate10;
    set indbom10;
    array items[3] dcitems whitems stitems;
    retain dcitems whitems stitems 0;

    do i=1 to _level_;
        if nitems then items[i]=items[i] + pct * nitems;
    end;

    if nitems then items[_level_+1]=items[_level_+1] + nitems;

    output;

    do i=_level_+1 to 3;
        items[i]=0;
    end;
run;

    /* Display the forecast for each store */
proc sort data=accumulate10(where=(code="ST"))
    out=stores10
    nodupkey;
    by _part_;
run;

proc print data=stores10 noobs;
    title1 'ABC Lamp Company';
    title3 'Totals for Stores';
    var _Part_ code stitems;
run;

    /* Display the aggregated forecast for each warehouse */
proc sort data=accumulate10(where=(code="WH"))
    out=houses10

```

```

        nodupkey;
    by _part_;
run;

proc print data=houses10 noobs;
    title1 'ABC Lamp Company';
    title3 'Totals for Warehouses';
    var _Part_ code whitems;
run;

/* Display the aggregated forecast for each distribution center */
proc sort data=accumulate10(where=(code="DC"))
    out=dcs10
    nodupkey;
    by _part_;
run;

proc print data=dcs10 noobs;
    title1 'ABC Lamp Company';
    title3 'Totals for Distribution Centers';
    var _Part_ code dcitems;
run;

```

Output 1.10.1. Forecasts for Stores

ABC Lamp Company		
Totals for Stores		
Part	code	stitems
Store 01	ST	10
Store 02	ST	20
Store 03	ST	10
Store 04	ST	20
Store 05	ST	10
Store 06	ST	20
Store 07	ST	10
Store 08	ST	20
Store 09	ST	10
Store 10	ST	20
Store 11	ST	10

Output 1.10.2. Aggregated Forecasts for Warehouses

ABC Lamp Company		
Totals for Warehouses		
Part	code	whitems
Warehouse 1	WH	40
Warehouse 2	WH	30
Warehouse 3	WH	50
Warehouse 4	WH	20
Warehouse 5	WH	20

Output 1.10.3. Aggregated Forecasts for Distribution Centers

ABC Lamp Company		
Totals for Distribution Centers		
Part	code	dcitems
Dist.Center 1	DC	70
Dist.Center 2	DC	90

Statement and Option Cross-Reference Tables

The following table references the options in the BOM procedure that are illustrated by the examples in this section. Note that the `DATA=`, `DUPLICATE=`, `OUT=`, `PMDATA=`, and `SUMMARYOUT=` options are specified on the `PROC BOM` statement. All other options are specified on the `STRUCTURE` statement.

Table 1.7. Options Specified in Examples

Option	1	2	3	4	5	6	7	8	9	10
<code>COMPONENT=</code>	X	X	X	X	X	X	X	X	X	X
<code>DATA=</code>	X	X	X	X	X	X	X	X	X	X
<code>DUPLICATE=</code>						X				
<code>ENDITEM=</code>						X				
<code>FACTOR=</code>			X			X			X	
<code>ID=</code>	X	X	X	X	X	X	X	X	X	X
<code>LEADTIME=</code>		X	X	X	X	X	X			
<code>OFFSET=</code>			X			X				
<code>OUT=</code>	X	X	X	X	X	X	X	X	X	X
<code>PARENT=</code>	X	X	X	X	X	X	X	X	X	X
<code>PART=</code>	X	X	X	X	X	X	X	X	X	X
<code>PMDATA=</code>			X	X	X	X	X	X		
<code>QTYONHAND=</code>		X							X	
<code>QUANTITY=</code>	X	X	X	X	X	X	X	X	X	X
<code>REQUIREMENT=</code>		X		X			X		X	
<code>RID=</code>			X			X				
<code>SUMMARYOUT=</code>	X	X	X	X			X		X	

References

- Aho, A. V., Hopcroft, J. E., and Ullman, J. D. (1983), *Data Structures and Algorithms*, Reading, MA: Addison-Wesley.
- Clement, J., Coldrick, A., and Sari, J. (1992), *Manufacturing Data Structures: Building Foundations for Excellence with Bills of Materials and Process Information*, Essex Junction, VT: Oliver Wright Limited Publications, Inc.
- Cox, J. F., III and Blackstone, J. H., Jr., eds. (1998), *APICS Dictionary*, Ninth Edition, Alexandria, VA: APICS.
- Fogarty, D. W., Blackstone, J. H., and Hoffmann, T. R. (1991), *Production and Inventory Management*, Second Edition, Cincinnati, OH: South-Western Publishing Co.
- Landvater, D. V. and Gray, C. D. (1989), *MRP II Standard System: A Handbook for Manufacturing Software Survival*, New York: John Wiley & Sons, Inc.
- Plossl, G. (1995), *Orlicky's Material Requirements Planning*, Second Edition, New York: McGraw-Hill, Inc.

Chapter 2

Bill-of-Material Post-Processing Macros

Chapter Contents

OVERVIEW	87
Input Data Sets	88
Software Requirements	90
Calling the Macros	90
Output Data Sets	90
Macro Variables	91
REPORTING MACROS	91
%BOMRMLB: Indented Bill of Material	92
%BOMRMLW: Indented Where-Used List	96
%BOMRSLB: Single-Level Bill of Material	99
%BOMRSLW: Single-Level Where-Used List	101
%BOMRSUB: Summarized Bill of Material	104
%BOMRSUW: Summarized Where-Used List	108
TRANSACTIONAL MACROS	111
%BOMTCNP: Copy-and-Paste Transaction	111
%BOMTDEL: Multiple-Delete Transaction	118
%BOMTREP: Multiple-Replace Transaction	121
%BOMTSAE: Same-as-Except Transaction	126
REFERENCES	132

Chapter 2

Bill-of-Material Post-Processing Macros

Overview

The bill-of-material post-processing macros are divided into two groups based on their functionality. The reporting macros generate miscellaneous reports from the [Indented BOM](#) output data set of PROC BOM, or a data set that contains indented bills of material. The reports include:

- Single-level bill of material
- Single-level where-used list
- Indented bill of material
- Indented where-used list
- Summarized bill of material
- Summarized where-used list

See the [“Indented BOM Data Set”](#) section (beginning on page 34) in [Chapter 1, “The BOM Procedure,”](#) for details on the Indented BOM data set.

The transactional macros perform specialized transactions for maintaining and updating the bills of material for a product, product line, plant, or company. The transactions include:

- Copy-and-paste
- Multiple-delete
- Multiple-replace
- Same-as-except

Used correctly, these transactions make it possible to avoid some clerical work and reduce the time to maintain the bills of material. However, if the transactions are used incorrectly, it may take hours to reconstruct what was changed automatically in a matter of seconds (Landvater and Gray 1989).

Input Data Sets

All SAS macros described in this chapter use a SAS input data set that contains the indented bills of material for all end items of the product line, plant, or company. This data set is referred to as the Indented BOM data set. It is typically the [Indented BOM](#) output data set created by PROC BOM. See the “[Indented BOM Data Set](#)” section (beginning on page 34) in [Chapter 1](#) for details on the variables and special structure of this SAS data set. Not every variable in the Indented BOM data set is needed in all macros. The variables required by each macro depend on the requirements of the macro, and are listed in the corresponding section describing each macro. Note that the macros depend heavily on the form of the Indented BOM data set that

- contains the complete indented bill of material for each end item.
- lists the components of each indented bill of material in the *depth-first* order.

Refer to Aho, Hopcroft, and Ullman (1983) for details on depth-first ordering. See also the “[Indented BOM Data Set](#)” section on page 34 in [Chapter 1](#) for details regarding the records in this data set.

A simple Indented BOM data set, `IndBOM`, is displayed in [Figure 2.1](#). It contains two indented bills of material, one for the item ‘A101’ and the other for the item ‘LA01’. You can easily check that each indented bill of material in this data set lists its components in depth-first order. The data set `IndBOM` is used as the Indented BOM input data set in all examples in this chapter.

You specify the name of the Indented BOM data set using the `IN=` parameter. If you do not provide a name when calling a post-processing macro, the macro uses the most recently created SAS data set as the Indented BOM data set.

One SAS macro, `%BOMTCNP`, requires an additional data set that contains the product structure record for the new parent-component relationship that will be created while performing the copy-and-paste transaction. This data set is referred to as the Product Structure data set. See the “[Product Structure Data Set](#)” section (beginning on page 32) in [Chapter 1](#) for details on this SAS data set.

Another SAS macro, `%BOMTSAE`, requires another data set that contains the part master record for the item specified in the `ROOT=` parameter of the macro. This data set is referred to as the Part Master data set. See the “[Part Master Data Set](#)” section (beginning on page 30) in [Chapter 1](#) for details on this SAS data set.

ABC Lamp Company									
Indented Bills of Material									
Obs	Level	Parent	Parent_ID	Part	Part_ID	Desc	Qty	Per	Fscrap
1	0	.	A101	0	Three-way socket assem.	.	.		
2	1	A101	0	1500	1	Steel holder	1	0.0	
3	2	1500	1	1400	2	1/4-20 Screw	2	0.0	
4	1	A101	0	1601	3	Three-way socket	1	0.0	
5	1	A101	0	1700	4	Wiring assembly	1	0.0	
6	2	1700	4	2200	5	16-Gauge lamp cord	12	0.1	
7	2	1700	4	2210	6	14-Gauge lamp cord	12	0.1	
8	2	1700	4	2300	7	Standard plug terminal	1	0.0	
9	0	.	LA01	8	Lamp LA	.	.		
10	1	LA01	8	A100	9	One-way socket assem.	1	0.0	
11	2	A100	9	1500	10	Steel holder	1	0.0	
12	3	1500	10	1400	11	1/4-20 Screw	2	0.0	
13	2	A100	9	1600	12	One-way socket	1	0.0	
14	2	A100	9	1700	13	Wiring assembly	1	0.0	
15	3	1700	13	2200	14	16-Gauge lamp cord	12	0.1	
16	3	1700	13	2210	15	14-Gauge lamp cord	12	0.1	
17	3	1700	13	2300	16	Standard plug terminal	1	0.0	
18	1	LA01	8	B100	17	Base assembly	1	0.0	
19	2	B100	17	1100	18	Finished shaft	1	0.0	
20	3	1100	18	2100	19	3/8 Steel tubing	26	0.2	
21	2	B100	17	1200	20	6-Diameter steel plate	1	0.0	
22	2	B100	17	1300	21	Hub	1	0.0	
23	2	B100	17	1400	22	1/4-20 Screw	4	0.0	
24	1	LA01	8	S100	23	Black shade	1	0.0	

Lead										
Obs	Qty	Prod	Unit	Time	Tot_Lead	LTOff	Tot_Off	SDate	EDate	Prod
1	1	Each	1	1	.	0	.	.	.	A101
2	1	Each	2	3	0	0	.	.	.	A101
3	2	Each	1	4	0	0	.	.	.	A101
4	1	Each	2	3	0	0	.	.	.	A101
5	1	Each	1	2	0	0	.	.	.	A101
6	12	Feet	2	4	0	0	.	07APR2001	.	A101
7	12	Feet	2	4	0	0	08APR2001	.	.	A101
8	1	Each	1	3	0	0	.	.	.	A101
9	1	Each	2	2	.	0	.	.	.	LA01
10	1	Each	1	3	2	2	.	.	.	LA01
11	1	Each	2	5	0	2	.	.	.	LA01
12	2	Each	1	6	0	2	.	.	.	LA01
13	1	Each	2	5	0	2	.	.	.	LA01
14	1	Each	1	4	0	2	.	.	.	LA01
15	12	Feet	2	6	0	2	.	07APR2001	.	LA01
16	12	Feet	2	6	0	2	08APR2001	.	.	LA01
17	1	Each	1	5	0	2	.	.	.	LA01
18	1	Each	1	3	0	0	.	.	.	LA01
19	1	Each	2	5	0	0	.	.	.	LA01
20	26	Inches	3	8	0	0	.	.	.	LA01
21	1	Each	3	6	0	0	.	.	.	LA01
22	1	Each	2	5	1	1	.	.	.	LA01
23	4	Each	1	4	3	3	.	.	.	LA01
24	1	Each	2	4	0	0	.	.	.	LA01

Figure 2.1. Indented BOM Data Set (IndBOM)

Software Requirements

This collection of SAS macros uses procedures from Base SAS and SAS/OR software, as shown in the following table:

SAS Software Module	Procedure	Used in Macros
Base SAS	SORT	%BOMRSLB, %BOMRSLW, %BOMRSUB, %BOMRSUW, %BOMTCNP, %BOMTREP, %BOMTSAE
Base SAS	SQL	%BOMRSLW, %BOMRSUB, %BOMRSUW
SAS/OR	BOM	%BOMTCNP, %BOMTREP, %BOMTSAE

Calling the Macros

The macros are part of the SAS Autocall library, and are automatically available for use in your SAS program, provided the SAS system option MAUTOSOURCE is in effect. For more information about autocall libraries, refer to *SAS Macro Language: Reference*.

All macros are defined using *keyword parameters*. With keyword parameters, you do not have to keep track of the positions of the parameters when calling any of the bill-of-material post-processing macros. The general format of a call to a macro in this chapter is:

```
%bommacro(keyword1=value1, keyword2=value2, ..., keywordn=valuen);
```

Each keyword parameter allows you to initialize a macro variable with the same name as the parameter inside the macro program to the value after the equals sign of a parameter. It is not necessary to specify all the keyword parameters in a macro program call. If you do not specify a keyword parameter, the macro program uses the default value of the parameter to initialize the corresponding macro variable. If the parameter does not have a default value defined for it, the corresponding macro variable is initialized with a null value. In a macro program call, no value after the equals sign of a parameter initializes the corresponding macro variable with a null value. Refer to Chapter 4, “Macro Programs,” in *SAS Macro Programming Made Easy* (Burlew 1998) for details on macros with keyword parameters.

Output Data Sets

Each macro in this chapter creates a SAS output data set. You can provide the name of this data set by specifying the OUT= parameter in each macro. If you do not provide a name when calling a post-processing macro, the macro creates an output data set named `_BOMOUT_`. This data set contains the same variables as the Indented BOM data set, except for those variables that are specified in the DROP= parameter. Some macros add new variables to the output data sets for particular information, such as quantity used and quantity needed, that are not contained in the Indented BOM data set.

Macro Variables

Each bill-of-material post-processing macro defines a macro variable named `_MACRONAME_`, where “*MACRONAME*” is the name of the macro. Each macro variable contains a character string that indicates the status of the corresponding macro execution. It is set at the completion of the macro execution. The form of the character string is `STATUS=status`, where *status* can be one of the following:

<code>SUCCESSFUL</code>	indicates successful completion of the macro.
<code>IO_ERROR</code>	indicates that the macro failed to open the input data sets or to create the output data set.
<code>RUNTIME_ERROR</code>	indicates that macro execution was halted due to an error found by the SAS System.
<code>RUNTIME_WARNING</code>	indicates that macro execution was completed, but a warning was issued by the SAS System.
<code>SYNTAX_ERROR</code>	indicates that macro execution was halted due to an error in the macro invocation syntax.
<code>SYNTAX_WARNING</code>	indicates that macro execution was completed, but a warning in the macro invocation syntax was issued.

You can check the SAS log for detailed error or warning messages if a macro variable has a value other than “`STATUS=SUCCESSFUL`”. These messages will help you determine the source of the errors. You can also use `MPRINT`, `MLOGIC`, `SYMBOLGEN`, or other SAS System options to help track down errors. For details, refer to the “Macro Facility Error Messages and Debugging” chapter in *SAS Macro Language: Reference*.

Reporting Macros

The reporting macros are used to construct reports from an [Indented BOM](#) output data set as produced by the BOM procedure. The macros contained in this section are as follows:

<code>%BOMRMLB</code>	constructs an indented bill of material
<code>%BOMRMLW</code>	constructs an indented where-used list
<code>%BOMRSLB</code>	constructs a single-level bill of material
<code>%BOMRSLW</code>	constructs a single-level where-used list
<code>%BOMRSUB</code>	constructs a summarized bill of material
<code>%BOMRSUW</code>	constructs a summarized where-used list

The *single-level bill of material* lists the components directly used by a given item. The *indented bill of material* of a given item lists all components that are directly or indirectly used by that item. It starts with the single-level bill of material for the

given item. Each component in this bill of material is checked to see if it has sub-components or a single-level bill of material. If so, the component is exploded. If any component on this second level bill has sub-components, that component is exploded in the same fashion. The explosion of bills of material continues until the lowest levels are reached (Landvater and Gray 1989). The *summarized bill of material* lists all components and their quantities that are directly or indirectly used to make prespecified units of the given item.

On the other hand, the *single-level where-used list* traces all parent items where the given item is directly used. The *indented where-used list* starts with the single-level where-used list of the given item, and traces upward to all the places each parent item is used, and so on until the top-level end item is reached. The *summarized where-used list* shows all parents at higher levels in which a given item is directly or indirectly used, along with the total quantities of the item used in those parents.

%BOMRMLB: Indented Bill of Material

```
%bomrmlb (ROOT=root, IN=SAS-data-set, LEV=variable, PARENT=variable,
          COMP=variable, QUANTITY=variable, QTYPROD=variable,
          FACTOR=variable, LEADTIME=variable, TOTLEAD=variable,
          OFFSET=variable, TOTOFF=variable, PARENID=variable,
          PROD=variable, REQ=req, OUT=SAS-data-set, DROP=variables);
```

constructs an indented bill of material for a given item referred to as the item Root, which lists all components directly or indirectly used in the item Root. If a component is a subassembly, all its components and all their components are also listed, down to purchased items and raw materials. The parameters for this macro are as follows:

ROOT=root

specifies the part number of the item for which the indented bill of material is constructed. This item is referred to as the item Root. You must specify either a number or a quoted string for the ROOT= parameter, depending on the type of the Component variable.

IN=SAS-data-set

names the Indented BOM input data set. The default value is the most recently created SAS data set. A null value is replaced by the default value.

LEV=variable

identifies the variable in the Indented BOM data set that contains the indenture level information. The default value is `_Level_`. A null value is replaced by the default value.

PARENT=variable

identifies the variable in the Indented BOM data set that contains the parent item's part number. A null value tells the macro program not to look for the variable in the input data set that contains the parent item's part number. The default value is `_Parent_`.

COMP=variable

identifies the variable in the Indented BOM data set that contains the component's

part number. This variable is referred to as the Component variable. The default value is `_Part_`. A null value is replaced by the default value.

QUANTITY=variable

identifies the variable in the Indented BOM data set that contains the quantity per assembly information. A null value tells the macro program not to look for the variable in the input data set that contains the quantity per assembly information. The default value is `Qty_Per`.

QTYPROD=variable

identifies the variable in the Indented BOM data set that contains the quantity per product information. A null value tells the macro program not to look for the variable in the input data set that contains the quantity per product information. The default value is `Qty_Prod`.

FACTOR=variable

identifies the variable in the Indented BOM data set that contains the scrap factor information. A null value tells the macro program not to look for the variable in the input data set that contains the scrap factor information. The default value is `S_Factor`.

LEADTIME=variable

identifies the variable in the Indented BOM data set that contains the lead time information. If you do not specify this parameter or specify a null value, the macro program will not look for the variable in the input data set that contains the lead time information.

TOTLEAD=variable

identifies the variable in the Indented BOM data set that contains the total lead time information. A null value tells the macro program not to look for the variable in the input data set that contains the total lead time information. The default value is `Tot_Lead`. The specification of the `TOTLEAD=` parameter is ignored if the macro program cannot find the variable in the Indented BOM data set that contains the lead time information.

OFFSET=variable

identifies the variable in the Indented BOM data set that contains the lead-time offset information. A null value tells the macro program not to look for the variable in the input data set that contains the lead-time offset information. The default value is `_Offset`.

TOTOFF=variable

identifies the variable in the Indented BOM data set that contains the the total lead-time offset information. A null value tells the macro program not to look for the variable in the input data set that contains the total lead-time offset information. The default value is `Tot_Off`. The specification of the `TOTOFF=` parameter is ignored if the macro program cannot find the variable in the Indented BOM data set that contains the lead-time offset information.

PARENID=variable

identifies the variable in the Indented BOM data set that contains the ID number for

the parent record. A null value tells the macro program not to look for the variable in the input data set that contains the ID number of the parent record. The default value is `Parent_ID`.

PROD=*variable*

identifies the variable in the Indented BOM data set that contains the end item's part number. A null value tells the macro program not to look for the variable in the input data set that contains the end item's part number. The default value is `_Prod_`.

REQ=*req*

specifies the quantity required for the item Root. The default value is 1. A null value is replaced by the default value.

OUT=*SAS-data-set*

names the output data set that contains indented bill of material for the item Root. The default value is `_BOMOUT_`. A null value is replaced by the default value.

DROP=*variables*

identifies all the variables in the Indented BOM data set that you do not want to be included in the output data set. You can list the variables in any form that SAS allows. If you do not specify the `DROP=` parameter, or specify a null value, all variables in the Indented BOM data set are included in the output data set.

The Input Data Set

The input data set for this macro is the Indented BOM data set described in the “[Input Data Sets](#)” section on page 88.

The following parameters specify the variables in the input data set that are required by the `%BOMRMLB` macro.

COMP= A character or numeric variable that contains the part number of the component.

LEV= A numeric variable that contains the indenture level information.

The following parameters specify the variables in the Indented BOM input data set that are used by the macro, if they can be found in the data set.

FACTOR= A numeric variable that contains the scrap factor information.

LEADTIME= A numeric variable that contains the lead time of the component.

OFFSET= A numeric variable that contains the lead-time offset information.

PARENID= A numeric variable that contains the ID number for the parent record.

PARENT= A character or numeric variable that contains the part number of the parent item. The type of this variable must be the same as that of the variable specified in the `COMP=` parameter.

PROD= A character or numeric variable that contains the part number of the end item. The type of this variable must be the same as that of the variable specified in the `COMP=` parameter.

QTYPROD=	A numeric variable that contains the quantity per product information.
QUANTITY=	A numeric variable that contains the quantity per assembly information.
TOTLEAD=	A numeric variable that contains the total lead time information.
TOTOFF=	A numeric variable that contains the total lead-time offset information.
DROP=	Variables that you do not want to be included in the output data set.

The Output Data Set

The output data set contains the indented bill of material for the item Root. This data set is a subset of the Indented BOM input data set, and has the same variables as the [Indented BOM data set](#), except for the variables that are specified in the DROP= parameter. The quantity per product (the value of the variable specified in the QTYPROD= parameter) of each record in this data set reflects the quantity needed in producing m units of the item Root, where m is the value specified in the REQ= parameter.

Note that the first record of the output data set does not contain a parent-component relationship. Therefore, the values for all variables that contain product structure information in this record have to be missing. The %BOMRMLB macro sets the values for the variables that are specified in the PARENT=, QUANTITY=, FACTOR=, and OFFSET= parameters to a missing value. It also sets the value of the variable specified in the PARENID= parameter to a missing value since the first record does not have a parent record. If there are other variables that also contain product structure data, you must manually set the values for those variables in the first record. See the “[Product Structure Data Set](#)” section (beginning on page 32) in [Chapter 1](#) for the variables that contain product structure information.

Macro Variable `_BOMRMLB_`

Upon completion, this macro defines a macro variable, `_BOMRMLB_`, which contains a character string that indicates the status of the macro execution. See the “[Macro Variables](#)” section on page 91 for the possible values of this macro variable.

An Example

The following statement constructs an indented bill of material for the item ‘A100’ from the Indented BOM data set displayed in [Figure 2.1](#) on page 89.

```
%bomrmlb(root='A100', in=IndBOM, quantity=QtyPer,
          factor=Fscrap, leadtime=LeadTime, offset=LTOff,
          out=BomOut1, drop=Paren_ID Part_ID _Prod_);
```

The indented bill of material for the item ‘A100’ is displayed in [Figure 2.2](#).

ABC Lamp Company											
Indented Bill of Material, Part A100											
				Q	L	T					
				t	e	T					
				y	a	t					
				s	_	d	L	t	S		
				P	U	T	L	T	D		
				r	r	n	i	e	O		
				e	a	o	i	m	a		
				r	p	d	t	e	d		
									f		
									f		
0	A100	One-way socket assem.	.	.	1	Each	1	1	.0	.	.
1	A100	1500 Steel holder	1	0.0	1	Each	2	3	0 0	.	.
2	1500	1400 1/4-20 Screw	2	0.0	2	Each	1	4	0 0	.	.
1	A100	1600 One-way socket	1	0.0	1	Each	2	3	0 0	.	.
1	A100	1700 Wiring assembly	1	0.0	1	Each	1	2	0 0	.	.
2	1700	2200 16-Gauge lamp cord	12	0.1	12	Feet	2	4	0 0	.	07APR2001
2	1700	2210 14-Gauge lamp cord	12	0.1	12	Feet	2	4	0 0	08APR2001	.
2	1700	2300 Standard plug terminal	1	0.0	1	Each	1	3	0 0	.	.

Figure 2.2. Indented Bill of Material for Item A100 (BomOut1)

%BOMRMLW: Indented Where-Used List

`%bomrmlw` (*ROOT=root*, *IN=SAS-data-set*, *LEV=variable*, *COMP=variable*, *QTYPROD=variable*, *QTYUSED=qtyused*, *OUT=SAS-data-set*, *DROP=variables*);

constructs an indented where-used list for a given item referred to as the item *Root*, which lists every parent item of the item *Root* and the respective quantities required, as well as each of their respective parent items, continuing until the end item is referenced (Cox and Blackstone 1998). The parameters for this macro are as follows:

ROOT=*root*

specifies the part number of the item for which the indented where-used list is constructed. This item is referred to as the item *Root*. You must specify either a number or a quoted string for the *ROOT=* parameter, depending on the type of the Component variable.

IN=*SAS-data-set*

names the Indented BOM input data set. The default value is the most recently created SAS data set. A null value is replaced by the default value.

LEV=*variable*

identifies the variable in the Indented BOM data set that contains the indenture level information. The default value is `_Level_`. A null value is replaced by the default value.

COMP=*variable*

identifies the variable in the Indented BOM data set that contains the component's part number. This variable is also referred to as the Component variable. The default value is `_Part_`. A null value is replaced by the default value.

QTYPROD=*variable*

identifies the variable in the Indented BOM data set that contains the quantity per product information. The default value is `Qty_Prod`. A null value tells the macro program not to look for the variable in the input data set that contains the quantity per product information.

QTYUSED=*qtyused*

specifies the name for the variable in the output data set that contains the quantity of the item Root used by the item identified by the the Component variable. A null value tells the macro program not to calculate and write the quantity-used information to the output data set. The default value is `Qty_Used`. The specification of the QTYUSED= parameter is ignored if the macro program cannot find the variable in the Indented BOM data set that contains the quantity per product information. The Indented BOM data set should not contain a variable with the name specified in the QTYUSED= parameter. Otherwise, the values of the variable with the name specified in the QTYUSED= parameter will be overwritten.

OUT=*SAS-data-set*

names the output data set that contains indented where-used list data for the item Root. The default value is `_BOMOUT_`. The null value is replaced by the default value.

DROP=*variables*

specifies all *variables* in the Indented BOM data set that you do not want to be included in the output data set. You can list the variables in any form that SAS allows. The default value is the variable that is specified in the QTYPROD= parameter. A null value tells the macro program to write all the variables in the Indented BOM data set to the output data set.

The Input Data Set

The input data set of this macro is the Indented BOM data set described in the “[Input Data Sets](#)” section on page 88.

The following parameters specify the variables in the input data set that are required by the %BOMRMLW macro.

COMP= A character or numeric variable that contains the part number of the component.

LEV= A numeric variable that contains the indenture level information.

The following parameters specify the variables in the Indented BOM input data set that are used by the macro, if they can be found in the data set.

QTYPROD= A numeric variable that contains the quantity per product information.

DROP= Variables that you do not want to be included in the output data set.

The Output Data Set

The output data set contains the indented where-used list for the item Root. This data set has the same variables as the [Indented BOM data set](#), except for those variables that are specified in the DROP= parameter. If both values for QTYPROD= and QTYUSED= parameters are not null, the output data set contains a new variable with the name specified by the following parameter:

QTYUSED= A numeric variable that contains the quantity of the item Root that is used in the item identified by the Component variable.

Macro Variable `_BOMRMLW_`

Upon completion, this macro defines a macro variable, `_BOMRMLW_`, which contains a character string that indicates the status of the macro execution. See the “[Macro Variables](#)” section on page 91 for the possible values of this macro variable.

An Example

The following statement constructs an indented where-used list for the item ‘1400’ from the Indented BOM data set displayed in [Figure 2.1](#) on page 89.

```
%bomrmlw(root='1400', in=IndBOM, qtyused=QtyUsed,
          out=BomOut2, drop=Paren_ID Part_ID Qty_Prod);
```

The indented where-used list for the item ‘1400’ is displayed in [Figure 2.3](#). In this list, the variable `QtyUsed` contains the quantity of the item ‘1400’ that is used in the item identified by the variable `_Part_`. For example, if you trace back from the item ‘1400’ up to the end item ‘A101’, you will observe that the item ‘1500’ uses 2 units of ‘1400’, and the item ‘A101’ uses 1 unit of ‘1500’, and hence, 2 units of ‘1400’. Therefore, the value for the variable `QtyUsed` is 2 on both observations 2 and 3.

ABC Lamp Company								
Indented Where-Used List, Part 1400								
Obs	_Level_	_Parent_	_Part_	Desc	Qty Per	Fscrap	Qty Used	
1	2	1500	1400	1/4-20 Screw	2	0	.	
2	1	A101	1500	Steel holder	1	0	2	
3	0		A101	Three-way socket assem.	.	.	2	
4	3	1500	1400	1/4-20 Screw	2	0	.	
5	2	A100	1500	Steel holder	1	0	2	
6	1	LA01	A100	One-way socket assem.	1	0	2	
7	0		LA01	Lamp LA	.	.	2	
8	2	B100	1400	1/4-20 Screw	4	0	.	
9	1	LA01	B100	Base assembly	1	0	4	
10	0		LA01	Lamp LA	.	.	4	

Obs	Unit	Lead Time	Tot_Lead	LTOff	Tot_Off	SDate	EDate	_Prod_
1	Each	1	4	0	0	.	.	A101
2	Each	2	3	0	0	.	.	A101
3	Each	1	1	.	0	.	.	A101
4	Each	1	6	0	2	.	.	LA01
5	Each	2	5	0	2	.	.	LA01
6	Each	1	3	2	2	.	.	LA01
7	Each	2	2	.	0	.	.	LA01
8	Each	1	4	3	3	.	.	LA01
9	Each	1	3	0	0	.	.	LA01
10	Each	2	2	.	0	.	.	LA01

Figure 2.3. Indented Where-Used List for Item 1400 (BomOut2)

%BOMRSLB: Single-Level Bill of Material

`%bomrslb` (*ROOT=root, IN=SAS-data-set, PARENT=variable, COMP=variable, OUT=SAS-data-set, DROP=variables*);

constructs a single-level bill of material for a given item referred to as the item Root, which lists all components that are directly used in the item Root. The parameters for this macro are as follows:

ROOT=*root*

specifies the part number of the item for which the single-level bill of material is constructed. This item is referred to as the item Root. You must specify either a number or a quoted string for the ROOT= parameter, depending on the type of the Component variable.

IN=*SAS-data-set*

names the Indented BOM input data set. The default value is the most recently created SAS data set. A null value is replaced by the default value.

PARENT=*variable*

identifies the variable in the Indented BOM data set that contains the parent item's part number. The default value is `_Parent_`. A null value is replaced by the default value.

COMP=variable

identifies the variable in the Indented BOM data set that contains the component's part number. This variable is also referred to as the Component variable. The default value is `_Part_`. A null value is replaced by the default value.

OUT=SAS-data-set

names the output data set that contains single-level bill of material data for the item Root. The default value is `_BOMOUT_`. A null value is replaced by the default value.

DROP=variables

specifies all variables in the Indented BOM data set that you do not want to be included in the output data set. You can list the variables in any form that SAS allows. The default value is the list of variables `_Level_`, `Paren_ID`, `Part_ID`, `_Prod_`, `Qty_Prod`, `Tot_Lead`, and `Tot_Off`, if they are in the Indented BOM data set. A null value tells the macro program to write all variables in the Indented BOM data set to the output data set.

The Input Data Set

The input data set of this macro is the Indented BOM data set described in the “[Input Data Sets](#)” section on page 88.

The following parameters specify the variables in the input data set that are required by the `%BOMRSLB` macro.

COMP=	A character or numeric variable that contains the part number of the component.
PARENT=	A character or numeric variable that contains the part number of the parent item. The type of this variable must be the same as that of the variable specified in the <code>COMP=</code> parameter.

The following parameter specifies the variables in the Indented BOM input data set that are used by the macro, if they can be found in the data set.

DROP=	Variables that you do not want to be included in the output data set.
--------------	---

The Output Data Set

The output data set contains the single-level bill of material for the item Root. This data set has the same variables as the [Indented BOM data set](#), except for those variables that are specified in the `DROP=` parameter.

Macro Variable `_BOMRSLB_`

Upon completion, this macro defines a macro variable, `_BOMRSLB_`, which contains a character string that indicates the status of the macro execution. See the “[Macro Variables](#)” section on page 91 for the possible values of this macro variable.

An Example

The following statement constructs a single-level bill of material for the item 'B100' from the Indented BOM data set displayed in Figure 2.1 on page 89.

```
%bomrslb(root='B100', in=IndBOM, out=BomOut3);
```

The single-level bill of material for the item 'B100' is displayed in Figure 2.4.

ABC Lamp Company								
Single-Level Bill of Material, Part B100								
Part	Parent	Description	Quantity	Factor	Unit	Level	Subtotal	End
—	P	D	Q	F	U	L	S	E
t	r	e	y	c	T	T	D	D
—	t	s	e	a	i	O	a	a
—	—	c	r	p	t	e	f	e
B100	1100	Finished shaft	1	0	Each	2	0	.
B100	1200	6-Diameter steel plate	1	0	Each	3	0	.
B100	1300	Hub	1	0	Each	2	1	.
B100	1400	1/4-20 Screw	4	0	Each	1	3	.

Figure 2.4. Single-Level Bill of Material for Item B100 (BomOut3)

%BOMRSLW: Single-Level Where-Used List

```
%bomrslw (ROOT=root, IN=SAS-data-set, PARENT=variable,
          COMP=variable, QUANTITY=variable, PARENID=variable,
          PARTID=variable, RID=variables, QTYUSED=qtyused,
          OUT=SAS-data-set, DROP=variables);
```

constructs a single-level where-used list for a given item referred to as the item Root, which lists each parent item in which the item Root is directly used and in what quantity. The parameters for this macro are as follows:

ROOT=root

specifies the part number of the item for which the single-level where-used list is constructed. This item is referred to as the item Root. You must specify either a number or a quoted string for the ROOT= parameter, depending on the type of the Component variable.

IN=SAS-data-set

names the Indented BOM input data set. The default value is the most recently created SAS data set. A null value is replaced by the default value.

PARENT=variable

identifies the variable in the Indented BOM data set that contains the parent item's

part number. The default value is `_Parent_`. A null value is replaced by the default value.

COMP=variable

identifies the variable in the Indented BOM data set that contains the component's part number. This variable is also referred to as the Component variable. The default value is `_Part_`. A null value of the corresponding macro variable is replaced by this default value in the macro program.

QUANTITY=variable

identifies the variable in the Indented BOM data set that contains the quantity per assembly information. A null value tells the macro program not to look for the variable in the input data set that contains the quantity per assembly information. The default value is `Qty_Per`.

PARENID=variable

identifies the variable in the Indented BOM data set that contains the ID number for the parent record. The default value is `Parent_ID`. A null value is replaced by the default value.

PARTID=variable

identifies the variable in the Indented BOM data set that contains the ID number for the current record. The default value is `Part_ID`. A null value is replaced by the default value.

RID=variables

identifies variables in the Indented BOM data set that contain the product structure information, and are not specified in `PARENT=`, `COMP=`, or `QUANTITY=` parameters. If you do not specify this parameter or specify a null value, the macro program assumes the Indented BOM data set contains no RID variables.

QTYUSED=qtyused

specifies the name for the variable in the output data set that contains the quantity of the item Root used by the parent item identified by the Component variable. A null value tells the macro program not to calculate and write the quantity-used information to the output data set. The default value is `Qty_Used`. The specification of the `QTYUSED=` parameter is ignored if the macro program cannot find the variable in the Indented BOM data set that contains the quantity per assembly information. The Indented BOM data set should not contain any variables with the name specified by the `QTYUSED=` parameter. Otherwise, the values of the variable with the name specified in the `QTYUSED=` parameter will be overwritten.

OUT=SAS-data-set

names the output data set that contains a single-level where-used list for the item Root. The default value is `_BOMOUT_`. A null value is replaced by this default value.

DROP=variables

specifies all variables in the Indented BOM data set that you do not want to be included in the output data set. You can list the variables in any form that SAS allows. The default value is the list that contains the variables specified in the `COMP=`,

QUANTITY=, PARENID=, and PARTID= parameters; plus the `_Level_`, `_Prod_`, `Qty_Prod`, `Tot_Lead`, and `Tot_Off` variables if they are in the Indented BOM data set. A null value tells the macro program to write all the variables in the Indented BOM data set to the output data set.

The Input Data Set

The input data set of this macro is the Indented BOM data set described in the “[Input Data Sets](#)” section on page 88.

The following parameters specify the variables in the input data set that are required by the %BOMRSLW macro.

COMP=	A character or numeric variable that contains the part number of the component.
PARENID=	A numeric variable that contains the ID number for the parent record.
PARENT=	A character or numeric variable that contains the part number of the parent item. The type of this variable must be the same as that of the variable specified in the COMP= parameter.
PARTID=	A numeric variable that contains the ID number for the current record.

The following parameters specify the variables in the Indented BOM input data set that are used by the macro, if they can be found in the data set.

QUANTITY=	A numeric variable that contains the quantity per assembly information.
RID=	Variables that contain product structure information, except for those specified in the COMP=, PARENT=, or QUANTITY= parameters.
DROP=	Variables that you do not want to be included in the output data set.

The Output Data Set

The output data set contains the single-level where-used list for the item Root. This data set has the same variables as the [Indented BOM data set](#), except for the variables specified in the DROP= parameter. If both values for the QUANTITY= and QTYUSED= parameters are not null, the output data set contains a new variable with the name specified by the following parameter:

QTYUSED=	A numeric variable that contains the quantity of the item Root that is used in the parent item identified by the the Component variable.
----------	--

Macro Variable `_BOMRSLW_`

Upon completion, this macro defines a macro variable, `_BOMRSLW_`, which contains a character string that indicates the status of the macro execution. See the “Macro Variables” section on page 91 for the possible values of this macro variable.

An Example

The following statement constructs a single-level where-used list for the item ‘1400’ from the Indented BOM data set displayed in Figure 2.1 on page 89.

```
%bomrslw(root='1400', in=IndBOM, quantity=QtyPer,
         rid=SDate EDate, qtyused=QtyUsed, out=BomOut4);
```

The single-level where-used list for the item ‘1400’ is displayed in Figure 2.5.

ABC Lamp Company								
Single-Level Where-Used List, Part 1400								
<u>Parent</u>	<u>Desc</u>	<u>Qty</u> <u>Used</u>	<u>Fscrap</u>	<u>Unit</u>	<u>Lead</u> <u>Time</u>	<u>LTOff</u>	<u>SDate</u>	<u>EDate</u>
1500	Steel holder	2	0	Each	2	0	.	.
B100	Base assembly	4	0	Each	1	0	.	.

Figure 2.5. Single-Level Where-Used List for Item 1400 (BomOut4)

%BOMRSUB: Summarized Bill of Material

```
%bomrsub (ROOT=root, IN=SAS-data-set, LEV=variable, PARENT=variable,
          COMP=variable, QUANTITY=variable, QTYPROD=variable,
          RID=variables, QTYREQ=qtyreq, REQ=req,
          OUT=SAS-data-set, DROP=variables);
```

constructs a summarized bill of material for a given item referred to as the item Root, which lists all the components and their quantities used to make m units of the item Root, where m is the value specified in the REQ= parameter. Unlike the indented bill of material, it does not list the levels of manufacture and lists a component only once for the total quantity used (Cox and Blackstone 1998). Note that the summarized bill of material created by this macro is more general than the one described in Chapter 1, where the total quantity used of each component is for making 1 unit of the item Root. The form of the summarized bill of material constructed by this macro enables you to determine how a future order for m units of the item Root will impact inventory levels. The parameters for this macro are as follows:

ROOT=root

specifies the part number of the item for which the summarized bill of material is constructed. This item is referred to as the item Root. You must specify either a number or a quoted string for the ROOT= parameter, depending on the type of the Component variable.

IN=SAS-data-set

names the Indented BOM input data set. The default value is the most recently created SAS data set. A null value is replaced by the default value.

LEV=variable

identifies the variable in the Indented BOM data set that contains the indenture level information. The default value is `_Level_`. A null value is replaced by the default value.

PARENT=variable

identifies the variable in the Indented BOM data set that contains the parent item's part number. A null value tells the macro program not to look for the variable in the input data set that contains the parent item's part number. The default value is `_Parent_`.

COMP=variable

identifies the variable in the Indented BOM data set that contains the component's part number. This variable is referred to as the Component variable. The default value is `_Part_`. A null value is replaced by the default value.

QUANTITY=variable

identifies the variable in the Indented BOM data set that contains the quantity per assembly information. A null value tells the macro program not to look for the variable in the input data set that contains the quantity per assembly information. The default value is `Qty_Per`.

QTYPROD=variable

identifies the variable in the Indented BOM data set that contains the quantity per product information. The default value is `Qty_Prod`. A null value is replaced by the default value.

RID=variables

identifies variables in the Indented BOM data set that contain product structure information and are not specified in the `PARENT=`, `COMP=`, or `QUANTITY=` parameters. These variables are only needed in creating the default drop variables. If you do not specify this parameter or specify a null value, the macro program assumes the Indented BOM data set contains no RID variables.

QTYREQ=qtyreq

specifies the name for the variable in the output data set that contains the quantity of the item identified by the Component variable that is used to make m units of the item Root, where m is the value specified in the `REQ=` parameter. The default value is `Qty_Req`. A null value is replaced by the default value. The Indented BOM data set should not contain any variables with the name specified by the `QTYREQ=` parameter. Otherwise, the values of the variable with the name specified in the `QTYREQ=` parameter will be overwritten.

REQ=req

specifies the quantity required for the item Root. The default value is 1. A null value is replaced by the default value.

OUT=SAS-data-set

names the output data set that contains summarized bill of material data. The default value is `_BOMOUT_`. A null value is replaced by this default value.

DROP=variables

identifies all variables in the Indented BOM data set that you do not want to be included in the output data set. You can list the variables in any form that SAS allows. The default value is the list that contains the variables specified in the `LEV=`, `PARENT=`, `QUANTITY=`, `QTYPROD=`, and `RID=` parameters, in addition to the `Paren_ID`, `Part_ID`, `_Prod_`, `Tot_Lead`, and `Tot_Off` variables, if they are in the Indented BOM data set. A null value tells the macro program to write all the variables in the Indented BOM data set to the output data set.

The Input Data Set

The input data set of this macro is the Indented BOM data set described in the “[Input Data Sets](#)” section on page 88.

The following parameters specify the variables in the input data set that are required by the `%BOMRSUB` macro.

<code>COMP=</code>	A character or numeric variable that contains the part number of the component.
<code>LEV=</code>	A numeric variable that contains the indenture level information.
<code>QTYPROD=</code>	A numeric variable that contains the quantity per product information.

The following parameters specify the variables in the Indented BOM input data set that are used by the macro, if they can be found in the data set.

<code>PARENT=</code>	A character or numeric variable that contains the part number of the parent item. The type of this variable must be the same as that of the variable specified in the <code>COMP=</code> parameter.
<code>QUANTITY=</code>	A numeric variable that contains the quantity per assembly information.
<code>RID=</code>	Variables that contain product structure information, except for those specified in the <code>PARENT=</code> , <code>COMP=</code> , or <code>QUANTITY=</code> parameters. These variables are only needed in creating the default drop variables.
<code>DROP=</code>	Variables that you do not want to be included in the output data set.

The Output Data Set

The output data set contains the summarized bill of material for the item Root. This data set has the same variables as the [Indented BOM data set](#), except for those variables specified in the `DROP=` parameter. The output data set contains a new variable with the name specified by the following parameter:

QTYREQ= A numeric variable that contains the quantity of the component identified by the Component variable that is used to produce *m* units of the item Root, where *m* is the value specified in the REQ= parameter.

Macro Variable _BOMRSUB_

Upon completion, this macro defines a macro variable, _BOMRSUB_, which contains a character string that indicates the status of the macro execution. See the “Macro Variables” section on page 91 for the possible values of this macro variable.

An Example

The following statement constructs a summarized bill of material for the item ‘LA01’ from the Indented BOM data set displayed in Figure 2.1 on page 89.

```
%bomrsub(root='LA01', in=IndBOM, quantity=QtyPer, qtyreq=QtyReq,
rid=SDate EDate LTOff Fscrap, req=50, out=BomOut5);
```

The summarized bill of material for the item ‘LA01’ is displayed in Figure 2.6. Note that a summarized bill of material lists a component only once for the total quantity used. For example, the total quantity of 300 units of the item ‘1400’ comes from 200 units that are for making 50 units of ‘B100’, and 100 units that are for producing 50 units of ‘1500’.

ABC Lamp Company				
Summarized Bill of Material, Part LA01: Requirement=50				
Part_	Desc	Unit	Lead Time	Qty Req
1100	Finished shaft	Each	2	50
1200	6-Diameter steel plate	Each	3	50
1300	Hub	Each	2	50
1400	1/4-20 Screw	Each	1	300
1500	Steel holder	Each	2	50
1600	One-way socket	Each	2	50
1700	Wiring assembly	Each	1	50
2100	3/8 Steel tubing	Inches	3	1300
2200	16-Gauge lamp cord	Feet	2	600
2210	14-Gauge lamp cord	Feet	2	600
2300	Standard plug terminal	Each	1	50
A100	One-way socket assem.	Each	1	50
B100	Base assembly	Each	1	50
S100	Black shade	Each	2	50

Figure 2.6. Summarized Bill of Material for Item LA01 (BomOut5)

%BOMRSUW: Summarized Where-Used List

`%bomrsuw` (*ROOT=root, IN=SAS-data-set, LEV=variable, COMP=variable, QUANTITY=variable, QTYPROD=variable, RID=variables, QTYUSED=qtyused, OUT=SAS-data-set, DROP=variables*);

constructs a summarized where-used list for a given item referred to as the item Root, which lists all parent items in which the item Root is directly or indirectly used and the required quantities. Unlike the indented where-used list, it does not list the levels of manufacture (Cox and Blackstone 1998). The parameters for this macro are as follows:

ROOT=*root*

specifies the part number of the item for which the summarized where-used list is constructed. This item is referred to as the item Root. You must specify either a number or a quoted string for the `ROOT=` parameter, depending on the type of the Component variable.

IN=*SAS-data-set*

names the Indented BOM input data set. The default value is the most recently created SAS data set. A null value is replaced by the default value.

LEV=*variable*

identifies the variable in the Indented BOM data set that contains the indenture level information. The default value is `_Level_`. A null value is replaced by the default value.

COMP=*variable*

identifies the variable in the Indented BOM data set that contains the component's part number. This variable is referred to as the Component variable. The default value is `_Part_`. A null value is replaced by the default value.

QUANTITY=*variable*

identifies the variable in the Indented BOM data set that contains the quantity per assembly information. This variable is only needed in creating the default drop variables. The default value is `Qty_Per`. A null value tells the macro program not to look for the variable that contains the quantity per assembly information.

QTYPROD=*variable*

identifies the variable in the Indented BOM data set that contains the quantity per product information. The default value is `Qty_Prod`. A null value is replaced by the default value.

RID=*variables*

identifies variables in the Indented BOM data set that contain product structure information and are not specified in `COMP=` or `QUANTITY=` parameters. These variables are only needed in creating the default drop variables. If you do not specify this parameter or specify a null value, the macro program assumes the Indented BOM data set contains no RID variables.

QTYUSED=*qtyused*

specifies the name for the variable in the output data set that contains the quantity of the item Root used by the parent item identified by the the Component variable. The default value is **Qty_Used**. A null value is replaced by the default value. The Indented BOM data set should not contain any variables with the name specified by the QTYUSED= parameter. Otherwise, the values of the variable with the name specified in the QTYUSED= parameter will be overwritten.

OUT=SAS-*data-set*

names the output data set that contains summarized where-used list data for the item Root. The default value is **_BOMOUT_**. A null value is replaced by the default value.

DROP=*variables*

specifies all variables in the Indented BOM data set that you do not want to be included in the output data set. The default value is the list that contains the variables specified in the LEV=, QUANTITY=, QTYPROD=, and RID= parameters, in addition to the **_Parent_**, **Paren_ID**, **Part_ID**, **_Prod_**, **Tot_Lead**, and **Tot_Off** variables, if they are in the Indented BOM data set. A null value tells the macro program to write all the variables in the Indented BOM data set to the output data set.

The Input Data Set

The input data set of this macro is the Indented BOM data set described in the “[Input Data Sets](#)” section on page 88. The following parameters specify the variables in the input data set that are required by the %BOMRSUW macro.

COMP=	A character or numeric variable that contains the part number of the component.
LEV=	A numeric variable that contains the indenture level information.
QTYPROD=	A numeric variable that contains the quantity per product information.

The following parameters specify the variables in the Indented BOM input data set that are used by the macro, if they can be found in the data set.

QUANTITY=	A numeric variable that contains the quantity per assembly information. This variable is only needed in creating the default drop variables.
RID=	Variables that contain product structure information, except for those specified in the COMP= or QUANTITY= parameters. These variables are only needed in creating the default drop variables.
DROP=	Variables that you do not want to be included in the output data set. These variables are optional.

The Output Data Set

The output data set contains the summarized where-used list for the item Root. This data set has the same variables as the [Indented BOM data set](#), except for the variables specified in the DROP= parameter. The output data set contains a new variable with the name specified by the following parameter:

QTYUSED= A numeric variable that contains the total quantities of the item Root used, directly or indirectly, in the item identified by the Component variable.

Macro Variable `_BOMRSUW_`

Upon completion, this macro defines a macro variable, `_BOMRSUW_`, which contains a character string that indicates the status of the macro execution. See the “[Macro Variables](#)” section on page 91 for the possible values of this macro variable.

An Example

The following statement constructs a summarized where-used list for the item ‘1400’ from the Summarized BOM data set as displayed in [Figure 2.1](#) on page 89.

```
%bomrsuw(root='1400', in=IndBOM, quantity=QtyPer,
          qtyused=QtyUsed, rid=SDate EDate LTOff Fscrap,
          out=BomOut6);
```

The summarized where-used list for the item ‘1400’ is displayed in [Figure 2.7](#). Note that a summarized where-used lists a parent item only once for the total quantity of the given component (the item ‘1400’ in this example) used by the parent item. For example, the item ‘LA01’ uses 6 units of the item ‘1400’, 4 units for making the item ‘B100’ and 2 for making ‘1500’. However, the summarized where-used list displayed in [Figure 2.7](#) shows that the item ‘1500’ uses 4 units of ‘1400’. This is because another 2 units are used in the bill of material for the end item ‘A101’.

ABC Lamp Company				
Summarized Where-Used List, Part 1400				
<u>Part</u>	<u>Desc</u>	<u>Unit</u>	<u>Lead Time</u>	<u>Qty Used</u>
1500	Steel holder	Each	2	4
A100	One-way socket assem.	Each	1	2
A101	Three-way socket assem.	Each	1	2
B100	Base assembly	Each	1	4
LA01	Lamp LA	Each	2	6

Figure 2.7. Summarized Where-Used List for Item 1400 (BomOut6)

Transactional Macros

The SAS macros described in this section perform specialized transactions for reducing the clerical time required to maintain the bills of material. These macros update **Indented BOM** data sets and are not concerned with the original **Part Master** and **Product Structure** data sets. Some companies use these two data sets to create an **Indented BOM** data set. Thereafter, they use, maintain, or update only the **Indented BOM** data set without referring again to the **Part Master** and **Product Structure** data sets.

The transactional macros enable you to make changes to the indented bill of material, such as replacing an item with another one, deleting an item, and so on. These macros should be used carefully. Used correctly, they enable you to avoid some clerical work and can be helpful in certain situations. However, if the macros are used incorrectly, it may take hours to reconstruct what was changed automatically in a matter of seconds (Landvater and Gray 1989).

The macros contained in this section are as follows:

- %BOMTCNP** performs copy-and-paste transaction
- %BOMTDEL** performs multiple-delete transaction
- %BOMTREP** performs multiple-replace transaction
- %BOMTSAE** performs same-as-except transaction

The *copy-and-paste* transaction copies a bill of material for a given item and attaches it to another parent item. This is normally followed by some transactions to change a few of the components in the copied bill of material. The *multiple-delete* transaction removes the entire bill of material for a given item in all its appearances. This transaction is used most often when an item is obsolete. The *multiple-replace* transaction searches the entire data set and replaces the bill of material for a given item with another in all its uses. This transaction is used when one item is replacing another in every bill of material where the original item is used (Landvater and Gray 1989). The *same-as-except* transaction creates a new bill of material that is a clone of an old one, and then replaces one item with another in all its appearances in the newly created bill.

%BOMTCNP: Copy-and-Paste Transaction

```
%bomtcnp (ROOT=root, ATTACH=attach, IN=SAS-data-set,
          PSDATA=SAS-data-set, PARENT=variable, PARENID=variable,
          COMP=variable, QUANTITY=variable, OFFSET=variable,
          FACTOR=variable, LEADTIME=variable, ID=variables,
          RID=variables, OUT=SAS-data-set);
```

performs the copy-and-paste transaction, which copies the bill of material for the item specified in the **ROOT=** parameter (referred to as the item Root), and attaches it to

the parent item specified in the ATTACH= parameter (referred to as the item Attach). The parameters for this macro are as follows:

ROOT=*root*

specifies the part number of the item for which the bill of material is copied. This item is referred to as the item Root. You must specify either a number or a quoted string for the ROOT= parameter, depending on the type of the Component variable.

ATTACH=*attach*

specifies the part number of the parent item to which the copied bill of material is attached. This item is referred to as the item Attach. You must specify either a number or a quoted string for the ATTACH= parameter, depending on the type of the Component variable.

IN=*SAS-data-set*

names the Indented BOM input data set. The default value is the most recently created SAS data set. A null value is replaced by the default value.

PSDATA=*SAS-data-set*

names the Product Structure input data set that contains the product structure record for the relationship between the parent item Attach and the component Root. The default value is `_BOMPS_`. A null value is replaced by the default value. If the data set specified in the PSDATA= parameter does not exist, the macro will create a data set `_BOMPS_` which contains the product structure record for the relationship between the item Attach and the item Root only. In this product structure record, the quantity per assembly is 1, and both the lead-time offset and the scrap factor are 0. The values of all RID variables for the product structure record are missing.

PARENT=*variable*

identifies the variable in the Indented BOM and the Product Structure data sets that contains the parent item's part number. The default value is `_Parent_`. A null value is replaced by the default value.

PARENID=*variable*

identifies the variable in the Indented BOM data set that contains the ID number for the parent record. The default value is `Paren_ID`. A null value is replaced by the default value.

COMP=*variable*

identifies the variable in the Indented BOM and the Product Structure data sets that contains the component's part number. This variable is referred to as the Component variable. The default value is `_Part_`. A null value is replaced by the default value.

QUANTITY=*variable*

identifies the variable in the Indented BOM and the Product Structure data sets that contains the quantity per assembly information. A null value tells the macro program not to look for the variable in both the Indented BOM and the Product Structure data sets that contains the quantity per assembly information. The default value is `Qty_Per`.

OFFSET=*variable*

identifies the variable in the Indented BOM and the Product Structure data sets that

contains the lead-time offset information. A null value tells the macro program not to look for the variable in both the Indented BOM and the Product Structure data sets that contains the lead-time offset information. The default value is `L_Offset`.

FACTOR=*variable*

identifies the variable in the Indented BOM and the Product Structure data sets that contains the scrap factor information. A null value tells the macro program not to look for the variable in both the Indented BOM and the Product Structure data sets that contains the scrap factor information. The default value is `S_Factor`.

LEADTIME=*variable*

identifies the variable in the Indented BOM data set that contains the lead time information. If you do not specify this parameter or specify a null value, the macro program will not look for the variable in the input data set that contains the lead time information.

ID=*variables*

identifies all ID variables in the Indented BOM data set that contain part master data and are not specified in the `COMP=` or `LEADTIME=` parameters. See the “[Part Master Data Set](#)” section (beginning on page 30) and the “[STRUCTURE Statement](#)” section (beginning on page 26), both in [Chapter 1](#) for details on the part master data and the ID variables. If you do not specify this parameter or specify a null value, the macro program assumes the Indented BOM data set contains no ID variables.

RID=*variables*

identifies all RID variables in the Indented BOM and Product Structure data sets that contain product structure data, and are not specified in the `PARENT=`, `COMP=`, `QUANTITY=`, `FACTOR=`, or `OFFSET=` parameters. See the “[Product Structure Data Set](#)” section (beginning on page 32) and the “[STRUCTURE Statement](#)” section (beginning on page 26), both in [Chapter 1](#) for details on the product structure data and the RID variables. If you do not specify this parameter or specify a null value, the macro program assumes both the Indented BOM and the Product Structure data sets contain no RID variables.

OUT=*SAS-data-set*

names the output data set that contains the modified indented bills of material. The default value is `_BOMOUT_`. A null value is replaced by the default value.

The Input Data Sets

The input data sets of this macro are the Indented BOM and the Product Structure data sets described in the “[Input Data Sets](#)” section on page 88. The Indented BOM data set contains the bills of material for all end items of the product line, plant, or company.

The following parameters specify the variables in the Indented BOM input data set that are required by the %BOMTCNP macro.

COMP= A character or numeric variable that contains the part number of the component.

PARENID=	A numeric variable that contains the ID number for the parent record.
PARENT=	A character or numeric variable that contains the part number of the parent item. The type of this variable must be the same as that of the variable specified in the COMP= parameter.

The following parameters specify the variables in the Indented BOM input data set that are used by the macro, if they can be found in the data set.

FACTOR=	A numeric variable that contains the scrap factor information.
ID=	Variables that contain part master information, except for those specified in the COMP= or LEADTIME= parameters.
LEADTIME=	A numeric variable that contains the lead time of the component.
OFFSET=	A numeric variable that contains the lead-time offset information.
QUANTITY=	A numeric variable that contains the quantity per assembly information.
RID=	Variables that contain product structure information, except for those specified in the COMP=, FACTOR=, OFFSET=, PARENT=, or QUANTITY= parameters.

The copy-and-paste transaction creates a new parent-component relationship with the item Attach as the parent item and the item Root as the component. The product structure data for this new relationship usually cannot be found in the Indented BOM input data set. Therefore, this macro needs a Product Structure input data set that contains the product structure record for the new relationship.

The following parameters specify the variables in the Product Structure data set that are required by the %BOMTCNP macro.

COMP=	A character or numeric variable that contains the part number of the component.
PARENT=	A character or numeric variable that contains the part number of the parent item. The type of this variable must be the same as that of the variable specified in the COMP= parameter.

The following parameters specify the variables in the Product Structure input data set that are used by the macro, if they can be found in the data set.

FACTOR=	A numeric variable that contains the scrap factor information. If the macro cannot find this variable in the Product Structure data set, it assumes the scrap factor of the new relationship is 0.
OFFSET=	A numeric variable that contains the lead-time offset information. If the macro cannot find this variable in the Product Structure data set, it assumes the lead-time offset of the new relationship is 0.

- QUANTITY=** A numeric variable that contains the quantity per assembly information. If the macro cannot find this variable in the Product Structure data set, it assumes the quantity per assembly of the new relationship is 1.
- RID=** Variables that contain product structure information, except for those specified in the **COMP=**, **FACTOR=**, **OFFSET=**, **PARENT=**, or **QUANTITY=** parameters. If the macro cannot find an RID variable in the Product Structure data set, but it is in the Indented BOM data set, it assumes the value of this variable is missing.

The Output Data Set

The output data set of this macro contains all the bills of material in the input data set, with the bill of material for the item Root that is copied and attached to the parent item Attach. This transaction is done by extracting the **Product Structure** data from the Indented BOM input data set. Thereafter, the product structure record for the new relationship with the item Attach as the parent item and the item Root as the component is added to this data set. The product structure record for this new relationship should be contained in the input data set with the name specified by the **PSDATA=** parameter. The **BOM procedure** is then invoked with the new Product Structure data set to create the new indented bills of material. Therefore, the output data set of this macro has the same variables as the **Indented BOM** output data set of the **BOM procedure**. See the “**Indented BOM Data Set**” section (beginning on page 34) in **Chapter 1** for the variables in this data set.

Macro Variable `_BOMTCNP_`

Upon completion, this macro defines a macro variable, `_BOMTCNP_`, which contains a character string that indicates the status of the macro execution. See the “**Macro Variables**” section on page 91 for the possible values of this macro variable.

An Example

In this example, we assume the engineers of the ABC Lamp Company decide that the wiring assembly (part number ‘1700’) also needs one 1/4-20 screw (part number ‘1400’). To modify the company’s bills of material data, they need to create a new product structure record for the relationship of the parent item ‘1700’ and the component ‘1400’. The Product Structure input data set, **ParComp1**, displayed in **Figure 2.8**, provides the product structure record for this new relationship.

ABC Lamp Company						
Product Structure Record; Parent 1700, Component 1400						
<u>_Parent_</u>	<u>_Part_</u>	Qty Per	Fscrap	LTOff	SDate	EDate
1700	1400	1

Figure 2.8. Product Structure Record for the Relationship 1700-1400 (ParComp1)

The following SAS code invokes the %BOMTCNP macro to perform the transaction.

```
%bomtcnp(root='1400', attach='1700', in=IndBOM, psdata=ParComp1,
quantity=QtyPer, offset=LTOff, factor=Fscrap,
leadtime=LeadTime, id=Desc Unit, rid=SDate EDate,
out=BomOut7);
```

The data set BomOut7 displayed in [Figure 2.9](#) contains the new indented bills of material. Note that the item '1400' is now used by the item '1700' in the bills of material for both end items 'A101' and 'LA01'.

ABC Lamp Company									
Indented Bills of Material									
Obs	Level	Parent	Parent_ID	Part	Part_ID	Desc	Qty	Per	Fscrap
1	0	.	A101	0	A101	Three-way socket assem.	.	.	
2	1	A101	0	1500	1	Steel holder	1	0.0	
3	2	1500	1	1400	2	1/4-20 Screw	2	0.0	
4	1	A101	0	1601	3	Three-way socket	1	0.0	
5	1	A101	0	1700	4	Wiring assembly	1	0.0	
6	2	1700	4	2200	5	16-Gauge lamp cord	12	0.1	
7	2	1700	4	2210	6	14-Gauge lamp cord	12	0.1	
8	2	1700	4	2300	7	Standard plug terminal	1	0.0	
9	2	1700	4	1400	8	1/4-20 Screw	1	0.0	
10	0	.	LA01	9	LA01	Lamp LA	.	.	
11	1	LA01	9	A100	10	One-way socket assem.	1	0.0	
12	2	A100	10	1500	11	Steel holder	1	0.0	
13	3	1500	11	1400	12	1/4-20 Screw	2	0.0	
14	2	A100	10	1600	13	One-way socket	1	0.0	
15	2	A100	10	1700	14	Wiring assembly	1	0.0	
16	3	1700	14	2200	15	16-Gauge lamp cord	12	0.1	
17	3	1700	14	2210	16	14-Gauge lamp cord	12	0.1	
18	3	1700	14	2300	17	Standard plug terminal	1	0.0	
19	3	1700	14	1400	18	1/4-20 Screw	1	0.0	
20	1	LA01	9	B100	19	Base assembly	1	0.0	
21	2	B100	19	1100	20	Finished shaft	1	0.0	
22	3	1100	20	2100	21	3/8 Steel tubing	26	0.2	
23	2	B100	19	1200	22	6-Diameter steel plate	1	0.0	
24	2	B100	19	1300	23	Hub	1	0.0	
25	2	B100	19	1400	24	1/4-20 Screw	4	0.0	
26	1	LA01	9	S100	25	Black shade	1	0.0	

Lead									
Obs	Qty_Prod	Unit	Time	Tot_Lead	LTOff	Tot_Off	SDate	EDate	Prod
1	1	Each	1	1	.	0	.	.	A101
2	1	Each	2	3	0	0	.	.	A101
3	2	Each	1	4	0	0	.	.	A101
4	1	Each	2	3	0	0	.	.	A101
5	1	Each	1	2	0	0	.	.	A101
6	12	Feet	2	4	0	0	.	07APR2001	A101
7	12	Feet	2	4	0	0	08APR2001	.	A101
8	1	Each	1	3	0	0	.	.	A101
9	1	Each	1	3	0	0	.	.	A101
10	1	Each	2	2	.	0	.	.	LA01
11	1	Each	1	3	2	2	.	.	LA01
12	1	Each	2	5	0	2	.	.	LA01
13	2	Each	1	6	0	2	.	.	LA01
14	1	Each	2	5	0	2	.	.	LA01
15	1	Each	1	4	0	2	.	.	LA01
16	12	Feet	2	6	0	2	.	07APR2001	LA01
17	12	Feet	2	6	0	2	08APR2001	.	LA01
18	1	Each	1	5	0	2	.	.	LA01
19	1	Each	1	5	0	2	.	.	LA01
20	1	Each	1	3	0	0	.	.	LA01
21	1	Each	2	5	0	0	.	.	LA01
22	26	Inches	3	8	0	0	.	.	LA01
23	1	Each	3	6	0	0	.	.	LA01
24	1	Each	2	5	1	1	.	.	LA01
25	4	Each	1	4	3	3	.	.	LA01
26	1	Each	2	4	0	0	.	.	LA01

Figure 2.9. Indented Bills of Material Updated by the Copy-And-Paste Transaction (BomOut7)

%BOMTDEL: Multiple-Delete Transaction

```
%bomtdel (ROOT=root, IN=SAS-data-set, LEV=variable,
          COMP=variable, OUT=SAS-data-set);
```

performs the multiple-delete transaction, which removes the entire bill of material for the item specified in the ROOT= parameter (referred to as item Root) in all its appearances. The parameters for this macro are as follows:

ROOT=root

specifies the part number of the item for which the bill of material is deleted from the Indented BOM data set. This item is referred to as the item Root. You must specify either a number or a quoted string for the ROOT= parameter, depending on the type of the Component variable.

IN=SAS-data-set

names the Indented BOM input data set. The default value is the most recently created SAS data set. A null value is replaced by the default value.

LEV=variable

identifies the variable in the Indented BOM data set that contains the indenture level information. The default value is `_Level_`. A null value is replaced by the default value.

COMP=variable

identifies the variable in the Indented BOM data set that contains the component's part number. This variable is referred to as the Component variable. The default value is `_Part_`. A null value is replaced by the default value.

OUT=SAS-data-set

names the output data set that contains the modified indented bills of material. The default value is `_BOMOUT_`. A null value is replaced by the default value.

The Input Data Set

The input data set of this macro is the Indented BOM data set described in the “[Input Data Sets](#)” section on page 88.

The following parameters specify the variables in the input data set that are required by the %BOMTDEL macro.

COMP= A character or numeric variable that contains the part number of the component.

LEV= A numeric variable that contains the indenture level information.

The Output Data Set

The output data set of this macro contains all the bills of material in the input data set except for the complete bill of material for the item Root, which is removed from the input data set in all places where the item Root appears. This data set has the same variables as the Indented BOM input data set.

Macro Variable `_BOMTDEL_`

Upon completion, this macro defines a macro variable, `_BOMTDEL_`, which contains a character string that indicates the status of the macro execution. See the “[Macro Variables](#)” section on page 91 for the possible values of this macro variable.

An Example

In this example, the engineers of the ABC Lamp Company decide to retire the item `'2200'`. The following code invokes the `%BOMTDEL` macro to remove the item `'2200'` from the Indented BOM data set, `IndBOM`, as displayed in [Figure 2.1](#) on page 89.

```
%bomtdel(root='2200', in=IndBOM, out=BomOut8);
```

The data set `BomOut8` displayed in [Figure 2.10](#) contains the updated indented bills of material of the company. Note that the item `'2200'` is removed from both bills of material for the end items `'A101'` and `'LA01'`.

ABC Lamp Company									
Indented Bills of Material									
Obs	Level	Parent	Parent_ID	Part	Part_ID	Desc	Qty	Per	Fscrap
1	0	.	A101	0	A101	Three-way socket assem.	.	.	
2	1	A101	0	1500	1	Steel holder	1	0.0	
3	2	1500	1	1400	2	1/4-20 Screw	2	0.0	
4	1	A101	0	1601	3	Three-way socket	1	0.0	
5	1	A101	0	1700	4	Wiring assembly	1	0.0	
6	2	1700	4	2210	6	14-Gauge lamp cord	12	0.1	
7	2	1700	4	2300	7	Standard plug terminal	1	0.0	
8	0	.	LA01	8	LA01	Lamp LA	.	.	
9	1	LA01	8	A100	9	One-way socket assem.	1	0.0	
10	2	A100	9	1500	10	Steel holder	1	0.0	
11	3	1500	10	1400	11	1/4-20 Screw	2	0.0	
12	2	A100	9	1600	12	One-way socket	1	0.0	
13	2	A100	9	1700	13	Wiring assembly	1	0.0	
14	3	1700	13	2210	15	14-Gauge lamp cord	12	0.1	
15	3	1700	13	2300	16	Standard plug terminal	1	0.0	
16	1	LA01	8	B100	17	Base assembly	1	0.0	
17	2	B100	17	1100	18	Finished shaft	1	0.0	
18	3	1100	18	2100	19	3/8 Steel tubing	26	0.2	
19	2	B100	17	1200	20	6-Diameter steel plate	1	0.0	
20	2	B100	17	1300	21	Hub	1	0.0	
21	2	B100	17	1400	22	1/4-20 Screw	4	0.0	
22	1	LA01	8	S100	23	Black shade	1	0.0	

Obs	Qty_Prod	Unit	Lead				SDate	EDate	Prod
			Time	Tot_Lead	LTOff	Tot_Off			
1	1	Each	1	1	.	0	.	A101	
2	1	Each	2	3	0	0	.	A101	
3	2	Each	1	4	0	0	.	A101	
4	1	Each	2	3	0	0	.	A101	
5	1	Each	1	2	0	0	.	A101	
6	12	Feet	2	4	0	0	08APR2001	A101	
7	1	Each	1	3	0	0	.	A101	
8	1	Each	2	2	.	0	.	LA01	
9	1	Each	1	3	2	2	.	LA01	
10	1	Each	2	5	0	2	.	LA01	
11	2	Each	1	6	0	2	.	LA01	
12	1	Each	2	5	0	2	.	LA01	
13	1	Each	1	4	0	2	.	LA01	
14	12	Feet	2	6	0	2	08APR2001	LA01	
15	1	Each	1	5	0	2	.	LA01	
16	1	Each	1	3	0	0	.	LA01	
17	1	Each	2	5	0	0	.	LA01	
18	26	Inches	3	8	0	0	.	LA01	
19	1	Each	3	6	0	0	.	LA01	
20	1	Each	2	5	1	1	.	LA01	
21	4	Each	1	4	3	3	.	LA01	
22	1	Each	2	4	0	0	.	LA01	

Figure 2.10. Indented Bills of Material Updated by the Multiple-Delete Transaction (BomOut8)

%BOMTREP: Multiple-Replace Transaction

```
%bomtrep (ROOT=root, REPBY=repby, IN=SAS-data-set,
          LEV=variable, PARENT=variable, PARENID=variable,
          COMP=variable, QUANTITY=variable, OFFSET=variable,
          FACTOR=variable, LEADTIME=variable, ID=variables,
          RID=variables, DEL=del, OUT=SAS-data-set);
```

performs the multiple-replace transaction, which replaces the bill of material for the item specified in the `ROOT=` parameter (referred to as the item Root) with the bill of material for the item specified in the `REPBY=` parameter (referred to as the item Repby) in all places where the item Root is used. The parameters for this macro are as follows:

ROOT=*root*

specifies the part number of the item for which the bill of material is replaced with the one for the item Repby in all places where it is used. This item is referred to as the item Root. You must specify either a number or a quoted string for the `ROOT=` parameter, depending on the type of the Component variable.

REPBY=*repby*

specifies the part number of the item for which the bill of material is replacing the one for the item Root in all places it is used. This item is referred to as the item Repby. You must specify either a number or a quoted string for the `REPBY=` parameter, depending on the type of the Component variable.

IN=*SAS-data-set*

names the Indented BOM input data set. The default value is the most recently created SAS data set. A null value is replaced by the default value.

LEV=*variable*

identifies the variable in the Indented BOM data set that contains the indenture level information. The default value is `_Level_`. A null value is replaced by the default value.

PARENT=*variable*

identifies the variable in the Indented BOM data set that contains the parent item's part number. The default value is `_Parent_`. A null value is replaced by the default value.

PARENID=*variable*

identifies the variable in the Indented BOM data set that contains the ID number for the parent record. The default value is `Paren_ID`. A null value is replaced by the default value.

COMP=*variable*

identifies the variable in the Indented BOM data set that contains the component's part number. The default value is `_Part_`. A null value is replaced by the default value.

QUANTITY=variable

identifies the variable in the Indented BOM data set that contains the quantity per assembly information. A null value tells the macro program not to look for the variable that contains the quantity per assembly information. The default value is `Qty_Per`.

OFFSET=variable

identifies the variable in the Indented BOM data set that contains the lead-time offset information. A null value tells the macro program not to look for the variable that contains lead-time offset information. The default value is `L_Offset`.

FACTOR=variable

identifies the variable in the Indented BOM data set that contains the scrap factor information. A null value tells the macro program not to look for the variable that contains the scrap factor information. The default value is `S_Factor`.

LEADTIME=variable

identifies the variable in the Indented BOM data set that contains the lead time information. If you do not specify this parameter or specify a null value, the macro program will not look for the variable in the input data set that contains the lead time information.

ID=variables

identifies all ID variables in the Indented BOM data set that contain part master data and are not specified in the `COMP=` or `LEADTIME=` parameters. See the “[Part Master Data Set](#)” section (beginning on page 30) and the “[STRUCTURE Statement](#)” section (beginning on page 26), both in [Chapter 1](#) for details on the part master data and the ID variables. If you do not specify this parameter or specify a null value, the macro program assumes the Indented BOM data set contains no ID variables.

RID=variables

identifies all RID variables in the Indented BOM data set that contain product structure data and are not specified in the `PARENT=`, `COMP=`, `QUANTITY=`, `FACTOR=`, or `OFFSET=` parameters. See the “[Product Structure Data Set](#)” section (beginning on page 32) and the “[STRUCTURE Statement](#)” section (beginning on page 26), both in [Chapter 1](#) for details on the product structure data and the RID variables. If you do not specify this parameter or specify a null value, the macro program assumes the Indented BOM data set contains no RID variables.

DEL=del

specifies either 0 or 1 to indicate whether or not the bill of material for the item Root should be removed after the replace transaction is done. The value 0 indicates that the bill of material should not be removed; any other value indicates that the bill of material should be removed. The default value is 0. A null value is replaced with the default value.

OUT=SAS-data-set

names the output data set that contains the modified indented bills of material. The default value is `_BOMOUT_`. A null value is replaced by this default value.

The Input Data Set

The input data set of this macro is the Indented BOM data set as described in the “Input Data Sets” section on page 88.

The following parameters specify the variables in the input data set that are required by the %BOMTREP macro.

COMP=	A character or numeric variable that contains the part number of the component.
LEV=	A numeric variable that contains the indenture level information.
PARENID=	A numeric variable that contains the ID number for the parent record.
PARENT=	A character or numeric variable that contains the part number of the parent item. The type of this variable must be the same as that of the variable specified in the COMP= parameter.

The following parameters specify the variables in the Indented BOM input data set that are used by the macro, if they can be found in the data set.

FACTOR=	A numeric variable that contains the scrap factor information.
ID=	Variables that contain part master information, except for those specified in the COMP= or LEADTIME= parameters.
LEADTIME=	A numeric variable that contains the lead time of the component.
OFFSET=	A numeric variable that contains the lead-time offset information.
QUANTITY=	A numeric variable that contains the quantity per assembly information.
RID=	Variables that contain product structure information, except for those specified in the COMP=, FACTOR=, OFFSET=, PARENT=, or QUANTITY= parameters.

The Output Data Set

The output data set contains all the bills of material in the input data set with the bill of material for the item Root replaced by the bill of material for the item Repby. This output data set has the same variables as the [Indented BOM](#) output data set of the [BOM procedure](#). See the “[Indented BOM Data Set](#)” section (beginning on page 34) in [Chapter 1](#) for the variables in this data set.

Macro Variable _BOMTREP_

Upon completion, this macro defines a macro variable, `_BOMTREP_`, which contains a character string that indicates the status of the macro execution. See the “[Macro Variables](#)” section on page 91 for the possible values of this macro variable.

An Example

In this example, the engineers of the ABC Lamp Company want to replace the one-way socket assembly (part number 'A100') with the three-way socket assembly (part number 'A101') in all places where 'A100' is used. The following code performs this multiple-replace transaction.

```
%bomtrep(root='A100', repby='A101', in=IndBOM, quantity=QtyPer,  
offset=LTOff, factor=Fscrap, leadtime=LeadTime,  
id=Desc Unit, rid=SDate EDate, del=1, out=BomOut9);
```

The data set BomOut9 displayed in [Figure 2.11](#) contains the updated indented bills of material of the company. Note that the item 'A100' is replaced by the item 'A101' in the bill of material for the end item 'LA01'. The bill of material for the item 'A100' is removed from the company's product structure because the parameter DEL=1 is specified in the invocation of the %BOMTREP macro.

ABC Lamp Company									
Indented Bills of Material									
Obs	Level	Parent	Parent_ID	Part	Part_ID	Desc	Qty		
							Per	Fscrap	
1	0		.	LA01	8	Lamp LA	.	.	
2	1	LA01	8	A101	9	Three-way socket assem.	1	0.0	
3	2	A101	9	1500	10	Steel holder	1	0.0	
4	3	1500	10	1400	11	1/4-20 Screw	2	0.0	
5	2	A101	9	1601	12	Three-way socket	1	0.0	
6	2	A101	9	1700	13	Wiring assembly	1	0.0	
7	3	1700	13	2200	14	16-Gauge lamp cord	12	0.1	
8	3	1700	13	2210	15	14-Gauge lamp cord	12	0.1	
9	3	1700	13	2300	16	Standard plug terminal	1	0.0	
10	1	LA01	8	B100	17	Base assembly	1	0.0	
11	2	B100	17	1100	18	Finished shaft	1	0.0	
12	3	1100	18	2100	19	3/8 Steel tubing	26	0.2	
13	2	B100	17	1200	20	6-Diameter steel plate	1	0.0	
14	2	B100	17	1300	21	Hub	1	0.0	
15	2	B100	17	1400	22	1/4-20 Screw	4	0.0	
16	1	LA01	8	S100	23	Black shade	1	0.0	

Lead									
Obs	Qty_Prod	Unit	Time	Tot_Lead	LTOff	Tot_Off	SDate	EDate	_Prod_
1	1	Each	2	2	.	0	.	.	LA01
2	1	Each	1	3	2	2	.	.	LA01
3	1	Each	2	5	0	2	.	.	LA01
4	2	Each	1	6	0	2	.	.	LA01
5	1	Each	2	5	0	2	.	.	LA01
6	1	Each	1	4	0	2	.	.	LA01
7	12	Feet	2	6	0	2	.	07APR2001	LA01
8	12	Feet	2	6	0	2	08APR2001	.	LA01
9	1	Each	1	5	0	2	.	.	LA01
10	1	Each	1	3	0	0	.	.	LA01
11	1	Each	2	5	0	0	.	.	LA01
12	26	Inches	3	8	0	0	.	.	LA01
13	1	Each	3	6	0	0	.	.	LA01
14	1	Each	2	5	1	1	.	.	LA01
15	4	Each	1	4	3	3	.	.	LA01
16	1	Each	2	4	0	0	.	.	LA01

Figure 2.11. Indented Bills of Material Updated by the Multiple-Replace Transaction (BomOut9)

%BOMTSAE: Same-as-Except Transaction

`%bomtsae` (*ROOT=root, SAMEAS=sameas, EXCEPT=except, REPBY=repby, IN=SAS-data-set, PMDATA=SAS-data-set, PART=variable, LEV=variable, PARENT=variable, PARENID=variable, COMP=variable, QUANTITY=variable, OFFSET=variable, FACTOR=variable, LEADTIME=variable, ID=variables, RID=variables, OUT=SAS-data-set*);

performs the same-as-except transaction, which creates a new indented bill of material for the item specified in the `ROOT=` parameter (referred to as the item Root), which is a clone of the bill of material for the item specified in the `SAMEAS=` parameter (referred to as the item Sameas). Then, it replaces the item specified in the `EXCEPT=` parameter (referred to as the item Except) with the item specified in the `REPBY=` parameter (referred to as the item Repby) in the newly created bills of material. Note that, unlike other transactional macros, the output data set of this macro contains the new bill of material for the item Root only. In addition, if the item Root is in the Indented BOM input data set, the bill of material for the item Root in the input data set may be different from the one in the output data set. The parameters for this macro are as follows:

ROOT=*root*

specifies the part number of the item for which the bill of material is a clone of the bill of material for the item Sameas. This item is referred to as the item Root. You must specify either a number or a quoted string for the `ROOT=` parameter, depending on the type of the Component variable. If you do not specify this parameter or specify a null value, the macro will only perform the “replace” transaction, which replaces the item Except with the item Repby in the bill of material for the item Sameas.

SAMEAS=*sameas*

specifies the part number of the item for which the bill of material is cloned. This item is referred to as the item Sameas. You must specify either a number or a quoted string for the `SAMEAS=` parameter, depending on the type of the Component variable.

EXCEPT=*except*

specifies the part number of the item for which the bill of material is replaced by the bill of material for item Repby in all its uses. This item is referred to as the item Except. You must specify either a number or a quoted string for the `EXCEPT=` parameter, depending on the type of the Component variable. If you do not specify this parameter or specify a null value, the macro will only perform the “clone” transaction, which copies the bill of material for the item Sameas to the item Root. In other words, the indented bill of material in the output data set is identical to the indented bill of material for the item Sameas in the Indented BOM input data set.

REPBY=*repby*

specifies the part number of the item for which the bill of material is replacing the bill of material for item Except. This item is referred to as the item Repby. You must specify either a number or a quoted string for the `REPBY=` parameter, depending on the type of the Component variable. If you do not specify this parameter or specify

a null value, the macro will remove the bill of material for the item Except in all its appearances in the new indented bill of material.

IN=SAS-data-set

names the Indented BOM input data set. The default value is the most recently created SAS data set. A null value is replaced by the default value.

PMDATA=SAS-data-set

names the Part Master input data set that contains the part master data for the item Root. The default value is the name specified by the IN= parameter. A null value is replaced by the default value. The PMDATA= parameter is ignored if you do not specify the ROOT= parameter, or specify a null value for it.

PART=variable

identifies the variable in the Part Master data set that contains the item's part number. The default is the variable specified in the COMP= parameter. A null value is replaced by the default value.

LEV=variable

identifies the variable in the Indented BOM data set that contains the indenture level information. The default value is `_Level_`. A null value is replaced by the default value.

PARENT=variable

identifies the variable in the Indented BOM data set that contains the parent item's part number. The default value is `_Parent_`. A null value is replaced by the default value.

PARENID=variable

identifies the variable in the Indented BOM data set that contains the ID number for the parent record. The default value is `Paren_ID`. A null value is replaced by the default value.

COMP=variable

identifies the variable in the Indented BOM data set that contains the component's part number. This variable is referred to as the Component variable. The default value is `_Part_`. A null value is replaced by the default value.

QUANTITY=variable

identifies the variable in the Indented BOM data set that contains the quantity per assembly information. A null value tells the macro program not to look for the variable that contains the quantity per assembly information. The default value is `Qty_Per`.

OFFSET=variable

identifies the variable in the Indented BOM data set that contains the lead-time offset information. A null value tells the macro program not to look for the variable that contains lead-time offset information. The default value is `L_Offset`.

FACTOR=variable

identifies the variable in the Indented BOM data set that contains the scrap factor information. A null value tells the macro program not to look for the variable that contains the scrap factor information. The default value is `S_Factor`.

LEADTIME=variable

identifies the variable in the Indented BOM and Part Master data sets that contains the lead time information. If you do not specify this parameter or specify a null value, the macro program will not look for the variable in the Indented BOM data set that contains the lead time information.

ID=variables

identifies all ID variables in the Indented BOM and Part Master data sets that contain part master data and are not specified in the PART=, COMP=, or LEADTIME= parameters. See the “[Part Master Data Set](#)” section (beginning on page 30) and the “[STRUCTURE Statement](#)” section (beginning on page 26), both in [Chapter 1](#) for details on the part master data and the ID variables. If you do not specify this parameter or specify a null value, the macro program assumes the Indented BOM data set contains no ID variables.

RID=variables

identifies all RID variables in the Indented BOM data set that contain product structure data and are not specified in the PARENT=, COMP=, QUANTITY=, FACTOR=, or OFFSET= parameters. See the “[Product Structure Data Set](#)” section (beginning on page 32) and the “[STRUCTURE Statement](#)” section (beginning on page 26), both in [Chapter 1](#) for details on the product structure data and the RID variables. If you do not specify this parameter or specify a null value, the macro program assumes the Indented BOM data set contains no RID variables.

OUT=SAS-data-set

names the output data set that contains the new indented bill of material for the item Root. The default value is `_BOMOUT_`. A null value is replaced by the default value.

Input Data Sets

The input data sets of this macro are the Indented BOM and the Part Master data sets described in the “[Input Data Sets](#)” section on page 88. The Indented BOM data set contains the bills of material for all end items of the product line, plant, or company.

The following parameters specify the variables the Indented BOM data set that are required by the %BOMTSAE macro.

COMP=	A character or numeric variable that contains the part number of the component.
LEV=	A numeric variable that contains the indenture level information.
PARENID=	A numeric variable that contains the ID number for the parent record.
PARENT=	A character or numeric variable that contains the part number of the parent item. The type of this variable must be the same as that of the variable specified in the COMP= parameter.

The following parameters specify the variables in the Indented BOM input data set that are used by the macro, if they can be found in the data set.

FACTOR=	A numeric variable that contains the scrap factor information.
ID=	Variables that contain part master information, except for those specified in the COMP= or LEADTIME= parameters.
LEADTIME=	A numeric variable that contains the lead time of the component.
OFFSET=	A numeric variable that contains the lead-time offset information.
QUANTITY=	A numeric variable that contains the quantity per assembly information.
RID=	Variables that contain product structure information, except for those specified in the COMP=, FACTOR=, OFFSET=, PARENT=, or QUANTITY= parameters.

Unlike other transactional macros, the item Root is not necessarily defined in the Indented BOM input data set. If it is not, you must specify a Part Master data set in the PMDATA= parameter that contains the part master record for the item Root. Otherwise, you can use the Indented BOM data set as the Part Master data set. The Part Master input data set may contain one part master record for the item Root only, or contain the part master records for all items, including the item Root, that are used in the company's product structure.

The following parameter specifies the variable in the Part Master data set that is required by the %BOMTSAE macro.

PART=	A character or numeric variable that contains the part number of the item. The type of this variable must be the same as that of the variable specified in the COMP= parameter.
-------	---

The following parameters specify the variables in the Product Structure input data set that are used by the macro, if they can be found in the data set.

ID=	Variables that contain part master information, except for those specified in the PART= or LEADTIME= parameters.
LEADTIME=	A numeric variable that contains the lead time of the component.

The Output Data Set

The output data set of this macro contains the bill of material for the item Root, which is a clone of the bill of material for the item Sameas, except the item Except, which is replaced by the item Repby in all its uses. The output data set has the same variables as the [Indented BOM](#) output data set of the [BOM procedure](#). See the “[Indented BOM Data Set](#)” section (beginning on page 34) in [Chapter 1](#) for the variables in this data set. Note that if the item Root is in the Indented BOM data set specified by the IN= parameter, the bill of material for the item Root in the input data set may be different from the one in this output data set.

Macro Variable `_BOMTSAE_`

Upon completion, this macro defines a macro variable, `_BOMTSAE_`, which contains a character string that indicates the status of the macro execution. See the “Macro Variables” section on page 91 for the possible values of this macro variable.

An Example

In this example, the engineers of the ABC Lamp Company need to create a new product, a lamp with three-way socket (part number ‘LA03’), which is the same as the lamp ‘LA01’ except that the new product has a three-way socket assembly (part number ‘A101’), instead of a one-way socket assembly (part number ‘A100’). They first create a part master record for the new product ‘LA03’. The Part Master input data set, `PMaster1`, displayed in [Figure 2.12](#), contains this part master record.

ABC Lamp Company			
Part Master Record; Part LA03			
Part	Desc	Unit	Lead Time
LA03	Lamp LA w/ 3-way socket	Each	2

Figure 2.12. Part Master Record for Item LA03 (`PMaster1`)

The following SAS code invokes the `%BOMTSAE` macro to perform the transaction.

```
%bomtsae(root='LA03', sameas='LA01', except='A100', repby='A101',
in=IndBOM, pmdata=PMaster1, part=Part, quantity=QtyPer,
offset=LTOff, factor=Fscrap, leadtime=LeadTime,
id=Desc Unit, rid=$Date EDate, out=BomOut10);
```

The data set `BomOut10` that contains the indented bill of material for the new item ‘LA03’ is displayed in [Figure 2.13](#).

ABC Lamp Company									
Indented Bill of Material, Part LA03									
Obs	Level	Parent	Parent_ID	Part	Part_ID	Desc	Qty	Per	Fscrap
1	0	.	LA03	8	Lamp LA w/ 3-way socket	.	.		
2	1	LA03	8	A101	9	Three-way socket assem.	1	0.0	
3	2	A101	9	1500	10	Steel holder	1	0.0	
4	3	1500	10	1400	11	1/4-20 Screw	2	0.0	
5	2	A101	9	1601	12	Three-way socket	1	0.0	
6	2	A101	9	1700	13	Wiring assembly	1	0.0	
7	3	1700	13	2200	14	16-Gauge lamp cord	12	0.1	
8	3	1700	13	2210	15	14-Gauge lamp cord	12	0.1	
9	3	1700	13	2300	16	Standard plug terminal	1	0.0	
10	1	LA03	8	B100	17	Base assembly	1	0.0	
11	2	B100	17	1100	18	Finished shaft	1	0.0	
12	3	1100	18	2100	19	3/8 Steel tubing	26	0.2	
13	2	B100	17	1200	20	6-Diameter steel plate	1	0.0	
14	2	B100	17	1300	21	Hub	1	0.0	
15	2	B100	17	1400	22	1/4-20 Screw	4	0.0	
16	1	LA03	8	S100	23	Black shade	1	0.0	

Lead									
Obs	Qty_Prod	Unit	Time	Tot_Lead	LTOff	Tot_Off	SDate	EDate	_Prod_
1	1	Each	2	2	.	0	.	.	LA03
2	1	Each	1	3	2	2	.	.	LA03
3	1	Each	2	5	0	2	.	.	LA03
4	2	Each	1	6	0	2	.	.	LA03
5	1	Each	2	5	0	2	.	.	LA03
6	1	Each	1	4	0	2	.	.	LA03
7	12	Feet	2	6	0	2	.	07APR2001	LA03
8	12	Feet	2	6	0	2	08APR2001	.	LA03
9	1	Each	1	5	0	2	.	.	LA03
10	1	Each	1	3	0	0	.	.	LA03
11	1	Each	2	5	0	0	.	.	LA03
12	26	Inches	3	8	0	0	.	.	LA03
13	1	Each	3	6	0	0	.	.	LA03
14	1	Each	2	5	1	1	.	.	LA03
15	4	Each	1	4	3	3	.	.	LA03
16	1	Each	2	4	0	0	.	.	LA03

Figure 2.13. Indented Bill of Material for Item LA03 (BomOut10)

References

- Aho, A. V., Hopcroft, J. E., and Ullman, J. D. (1983), *Data Structures and Algorithms*, Reading, MA: Addison-Wesley.
- Burlew, M. M. (1998), *SAS Macro Programming Made Easy*, Cary, NC: SAS Institute Inc.
- Cox, J. F., III and Blackstone, J. H., Jr., eds. (1998), *APICS Dictionary*, Ninth Edition, Alexandria, VA: APICS.
- Landvater, D. V. and Gray, C. D. (1989), *MRP II Standard System: A Handbook for Manufacturing Software Survival*, New York: John Wiley & Sons, Inc.
- Plossl, G. (1995), *Orlicky's Material Requirements Planning*, Second Edition, New York: McGraw-Hill, Inc.

Appendix A

BOM Web Example

Appendix Contents

OVERVIEW	135
DATA	135
Part Master File	136
Product Structure File	137
Planned Orders	138
REPORTS	139
Product Structure Reports	139
Miscellaneous Reports	142
Shortage and Critical Path Analysis Reports	146

Appendix A

BOM Web Example

Overview

The BOM procedure and the macros described in this book can be used to maintain and update bills of material and produce related reports for use in the manufacturing process. The output data set produced by the BOM procedure can be used to plan for material requirements and analyze the critical path for planned orders. This appendix illustrates this process using a sample Web demo as a detailed example. In this example, 48 different items are used in the production of four final products: a 3-gallon carpet cleaner, a 4-gallon carpet cleaner, a 5-gallon carpet cleaner, and a bottled concentrate.

This application supports several different types of bills of material, providing valuable and diverse views of product makeup and part/component/material usage. It also reports on upcoming shortages and identifies the shortage status of critical parts and components. The example enables you to explore how each assembly or sub-assembly of a final product is manufactured, and also enables you to investigate how, where, and in what quantities any specific part or material is used. Combining this information with lead time and order information, you can identify upcoming shortages, gauge their effects on timely order fulfillment, and set procurement priorities accordingly.

Note: The BOM Web demo is a client-server application driven from your desktop and running at SAS Institute in Cary, NC. You can access the demo from SAS Institute's Supply Chain Web site (http://support.sas.com/sassamples/demos/supplychain/demos/bom/bom_ex_index.html). The graphs and reports in the demo have not been saved but are calculated on demand; this means that they change dynamically as the data used to calculate them change. This demo requires Internet Explorer, version 5.0 or later.

Data

There are three main components to the data used to maintain bills of material and evaluate effects of planned orders: Part Master File, Product Structure File, and Planned Orders. This example illustrates typical forms of these data elements.

The data for the BOM Web example are directly related to the data sets required for the BOM procedure, as discussed in [Chapter 1, "The BOM Procedure."](#) The Part Master File and Planned Orders file together correspond to the `PMDATA=` data set, and the Product Structure File corresponds to the `DATA=` data set. Refer to [Chapter 1](#) for more information about these data sets and PROC BOM.

Part Master File

The Part Master File includes, for each item:

- Part number and description
- Unit cost
- Lead time
- Lot size (for replenishment)
- Unit of measure
- Item type

The Part Master File for the BOM Web example is shown in [Figure A.1](#). Typical transactional operations required to maintain bills of material can be performed using the transactional macros described in [Chapter 2, “Bill-of-Material Post-Processing Macros.”](#) Some of these operations are illustrated using this table. You can add a new part using the top table, update the data for existing parts using the bottom table, and delete multiple parts simultaneously. Refer to [Chapter 2](#) for information on the BOM transactional macros.

Bills of Material
Home Data Reports

View and Edit Reset

Part Master File
Product Structure File
Planned Orders
Replace and Copy

Add New Part

Part Number	Part Description	Unit Cost	Lead Time	Lot Size	Unit	Type
<input style="width: 95%;" type="text"/>	<input style="width: 95%;" type="text"/>	<input style="width: 95%;" type="text"/>	<input style="width: 95%;" type="text"/>	<input style="width: 95%;" type="text"/>	<input style="width: 95%;" type="text"/>	<input style="width: 95%;" type="text"/>

Edit Part Master File

	Part Number	Part Description	Unit Cost	Lead Time	Lot Size	Unit	Type
<input type="checkbox"/>	0041	Ammonium Hydroxide	50	35	100000	Grams	2
<input type="checkbox"/>	0123	3-Gal Carpet Cleaner	8	7	50	Ea	3
<input type="checkbox"/>	0124	4-Gal Carpet Cleaner	10	7	50	Ea	3
<input type="checkbox"/>	0125	5-Gal Carpet Cleaner	9	7	50	Ea	3
<input type="checkbox"/>	0403	Clamp	22	14	200	Ea	2
<input type="checkbox"/>	1115	Customer Pack	6	7	200	Ea	1
<input type="checkbox"/>	1196	S-Housing	23	14	120	Ea	1

Figure A.1. Part Master File

Product Structure File

The Product Structure File describes each parent-component relationship, using the following information:

- Part number for the parent item
- Part number for the component
- Quantity of the component used in the parent item

The Product Structure File for the BOM Web example is shown in [Figure A.2](#).

Bills of Material

Home | Data | Reports

View and Edit

- Part Master File
- Product Structure File**
- Planned Orders
- Replace and Copy

Add New Parent-Component Relationship

Parent	Component	Qty. Per Assembly*
<input type="text"/>	<input type="text"/>	<input type="text"/>

Edit Parent-Component Relationships

	Parent	Component	Qty. Per Assembly*
<input type="checkbox"/>	0123 / 3-Gal Carpet Cleaner	1115 / Customer Pack	<input type="text" value="1"/>
<input type="checkbox"/>	0123 / 3-Gal Carpet Cleaner	2927 / 3-Gal Tank Assembly	<input type="text" value="1"/>
<input type="checkbox"/>	0123 / 3-Gal Carpet Cleaner	3804 / 1-Hp Housing Assembly	<input type="text" value="1"/>
<input type="checkbox"/>	0123 / 3-Gal Carpet Cleaner	4651 / Handle Assembly	<input type="text" value="1"/>
<input type="checkbox"/>	0124 / 4-Gal Carpet Cleaner	1115 / Customer Pack	<input type="text" value="1"/>
<input type="checkbox"/>	0124 / 4-Gal Carpet Cleaner	1527 / 4-Gal Tank Assembly	<input type="text" value="1"/>
<input type="checkbox"/>	0124 / 4-Gal Carpet Cleaner	3814 / 1.5-Hp Housing Assembly	<input type="text" value="1"/>
<input type="checkbox"/>	0124 / 4-Gal Carpet Cleaner	4651 / Handle Assembly	<input type="text" value="1"/>

* "Qty. Per Assembly" refers to the amount of this component required for a single parent item.

Figure A.2. Product Structure File

Planned Orders

To use bill of materials information in analyzing material requirements and anticipated shortages, it is necessary to keep records of all planned orders. A planned order is a future demand for a given quantity of a final product, which must be filled by a specified due date. The Planned Orders data describe each planned order, listing the following information for each order:

- Part number and description for the final product or master schedule item
- Order quantity
- Due date

The Planned Orders file for the BOM Web example is shown in [Figure A.3](#). The planned order information is carried along to the indented bill of materials, and can be used to calculate material requirement schedules for the planned orders, as described in the “[Shortage and Critical Path Analysis Reports](#)” section on page 146.

Bills of Material

Home Data Reports

View and Edit

Part Master File

Product Structure File

Planned Orders

Replace and Copy

Add New Order

Part Number	Order Quantity	Due Date
<input type="text"/>	<input type="text"/>	<input type="text"/>

Edit Orders

	Part Number	Part Description	Order Quantity	Due Date
<input type="checkbox"/>	0123	3-Gal Carpet Cleaner	<input type="text" value="40"/>	<input type="text" value="27SEP2001"/>
<input type="checkbox"/>	0124	4-Gal Carpet Cleaner	<input type="text" value="45"/>	<input type="text" value="27SEP2001"/>
<input type="checkbox"/>	0125	5-Gal Carpet Cleaner	<input type="text" value="40"/>	<input type="text" value="27SEP2001"/>

Figure A.3. Planned Orders

Reports

Several reports can be generated using the output from the BOM procedure described in [Chapter 1](#) and the reporting macros described in [Chapter 2](#). This section illustrates several such reports, grouped by categories: Product Structure Reports, Miscellaneous Reports, and Shortage and Critical Path Analysis Reports

Product Structure Reports

The Product Structure Reports include a summarized parts list and indented bills of material; these reports are described in detail in the following sections.

Summarized Parts List

The summarized parts list combines the summarized bills of material for all final products or master schedule items. The gross requirement for any final product is the total planned order quantity for that final product. The net requirement is calculated as the gross requirement minus the quantity on hand.

The summarized parts list is given by the `SUMMARYOUT=` output data set in PROC BOM. For details about this data set, see the “[Summarized Parts Data Set](#)” section beginning on page 40. [Figure A.4](#) shows the summarized parts list for the BOM Web example.

Summarized Parts List
across all planned orders

Part Number	Low-Level Code	Gross Req.	Qty. On Hand	Net Req.	Part Description	Unit	Lot Size	Type	Unit Cost
5640	4	1392.5	0	1392.5	Steel	Lbs	2500	2	115
5746	2	1250	0	1250	Hose	In	2400	2	45
4315	2	375	0	375	Brush Assembly	Ea	600	2	77
1201	3	250	0	250	Gasket	Ea	360	2	3
0403	3	125	0	125	Clamp	Ea	200	2	22
4209	3	125	0	125	Painted Tank Top	Ea	200	1	18
1959	2	125	0	125	Instruct Set	Ea	200	2	8
2156	2	125	0	125	Trigger Assembly	Ea	180	2	78
3215	2	125	0	125	Solution Tank	Ea	200	2	65
3219	2	125	0	125	Handle	Ea	200	2	89
5319	2	125	0	125	Valve Assembly	Ea	200	2	137
6221-1	2	125	0	125	Bottled Concentrate	Ea	300	2	150
7114	2	125	0	125	Power Cord	Ea	300	2	23
1115	1	125	0	125	Customer Pack	Ea	200	1	6
4651	1	125	0	125	Handle Assembly	Ea	200	1	12
1196	2	85	0	85	S-Housing	Ea	120	1	23
5705	3	45	0	45	4-Gal Painted Tank Bottom	Ea	60	1	37

Figure A.4. Summarized Parts List

Indented BOM

To reduce the size of the displays, the indented bill of material can be separated into a bill of material for each final product. [Chapter 2](#) describes a macro, `%BOMRMLB`, that constructs an indented bill of material for a selected item.

[Figure A.5](#) shows the tabular view of the Indented BOM for the 5-Gal Carpet Cleaner. In the BOM Web example, each part number is selectable and produces the Indented BOM for the item identified by the selected part number. You can also selectively collapse or expand sections of the Indented BOM by clicking on the - and + icons next to the part numbers.

Indented BOM for Product 0125
5-Gal Carpet Cleaner

Ind. Level	Part Number	Part Description	Type	Unit	Qty. Per Assembly	Unit Cost	Lead Time	Total Lead Time
0	☐ 0125	5-Gal Carpet Cleaner	3	Ea	.	9	7	7
1	☐ 1115	Customer Pack	1	Ea	1	6	7	14
2	- 1959	Instruct Set	2	Ea	1	8	7	21
2	- 6221-1	Bottled Concentrate	2	Ea	1	150	105	119
1	☐ 2104	5-Gal Tank Assembly	1	Ea	1	30	14	21
2	- 5319	Valve Assembly	2	Ea	1	137	91	112
2	- 5746	Hose	2	In	10	45	28	49
2	☐ 7350	5-Gal Tank Subassembly	1	Ea	1	25	14	35
3	- 0403	Clamp	2	Ea	1	22	14	49
3	- 1201	Gasket	2	Ea	2	3	7	42
3	☐ 4209	Painted Tank Top	1	Ea	1	18	14	49
4	- 5640	Steel	2	Lbs	2	115	70	119
3	☐ 5706	5-Gal Painted Tank Bottom	1	Ea	1	38	21	56
4	- 5640	Steel	2	Lbs	3	115	70	126
1	☐ 3824	2-Hp Housing Assembly	1	Ea	1	17	14	21
2	☐ 1198	M-Housing	1	Ea	1	25	14	35

Figure A.5. Indented BOM, Tabular View

[Figure A.6](#) shows the diagram view of the Indented BOM for the 5-Gal Carpet Cleaner. Each node in the diagram represents a record in the tabular view as displayed in [Figure A.5](#). This diagram is generated using the NETDRAW procedure; [Example 1.1](#) in [Chapter 1](#) illustrates the use of PROC NETDRAW to draw a tree diagram for an indented bill of material. In addition, you can use the WEB= option in PROC NETDRAW to construct a “clickable” Indented BOM diagram. For example, clicking on the node “2104” in [Figure A.6](#) produces the Indented BOM shown in [Figure A.7](#).

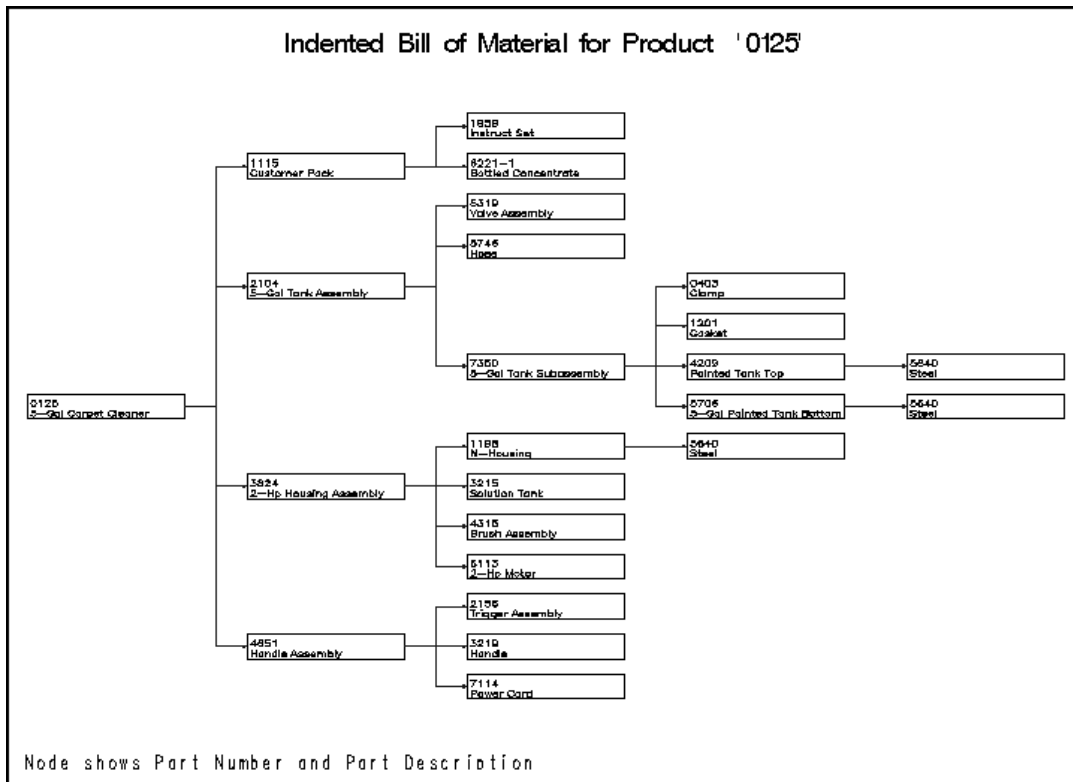

Figure A.6. Indented BOM, Diagram View

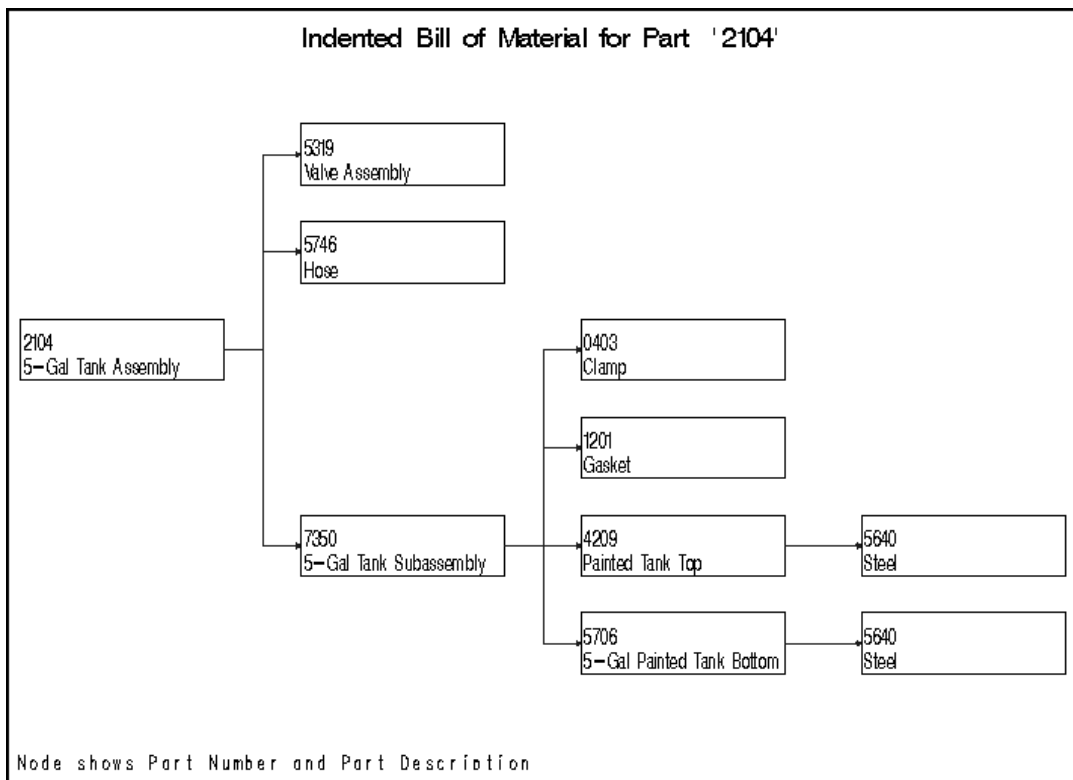

Figure A.7. Indented BOM, Diagram View Drilldown

Miscellaneous Reports

In addition to the Summarized Parts List and Indented BOM reports described in the “Product Structure Reports” section on page 139, the output from PROC BOM and the BOM reporting macros can also be used to generate summarized bills of material, gross requirement summaries, and where-used lists.

Summarized BOM

The Summarized BOM for an item describes all the parts and their total quantity required in the production of the item. For each component, the Summarized BOM lists the following information:

- Part number and description for the component
- Quantity required to make one unit of the end item
- Item type
- Unit of measure
- Unit cost
- Lead time

The Summarized BOM for the 5-Gal Tank Assembly in the BOM Web example is shown in Figure A.8. Chapter 2 describes a macro, %BOMRSUB, that constructs a summarized bill of material for a selected item.

Summarized BOM for Part 2104

5-Gal Tank Assembly
Quantity Required: 1

Component	Component Description	Qty. Required	Type	Unit	Unit Cost	Lead Time
<u>0403</u>	Clamp	1	2	Ea	22	14
<u>1201</u>	Gasket	2	2	Ea	3	7
<u>4209</u>	Painted Tank Top	1	1	Ea	18	14
<u>5319</u>	Valve Assembly	1	2	Ea	137	91
<u>5640</u>	Steel	5	2	Lbs	115	70
<u>5706</u>	5-Gal Painted Tank Bottom	1	1	Ea	38	21
<u>5746</u>	Hose	10	2	In	45	28
<u>7350</u>	5-Gal Tank Subassembly	1	1	Ea	25	14

Figure A.8. Summarized BOM

Gross Requirement Summary

The Gross Requirement Summary for an item lists the quantities of all components needed to produce the required quantity of the item. This report enables you to analyze how future orders for an item will impact inventory levels. See the “[Summarized Parts Data Set](#)” section beginning on page 40 and [Example 1.9](#) in [Chapter 1](#) for details about the gross requirement calculation.

For each component, the Gross Requirement Summary includes the following:

- Part number and description for the component
- Quantity required
- Quantity on hand
- Item type
- Unit of measure
- Unit cost
- Lead time

[Figure A.9](#) shows the Gross Requirement Summary report for the 5-Gal Tank Assembly with a required quantity of 40. Notice that this report is similar to the Summarized BOM in [Figure A.8](#), with a column “Gross Req.” that is 40 times the “Qty. Required” column from the Summarized BOM. The Gross Requirement Summary also includes a column for quantity on hand for inventory status information to compare with component requirements.

Gross Requirement Summary for Part 2104

5-Gal Tank Assembly
Quantity Required: 40

Component	Component Description	Gross Req.	Qty. On Hand	Type	Unit	Unit Cost	Lead Time
0403	Clamp	40	0	2	Ea	22	14
1201	Gasket	80	0	2	Ea	3	7
4209	Painted Tank Top	40	0	1	Ea	18	14
5319	Valve Assembly	40	0	2	Ea	137	91
5640	Steel	200	0	2	Lbs	115	70
5706	5-Gal Painted Tank Bottom	40	0	1	Ea	38	21
5746	Hose	400	0	2	In	45	28
7350	5-Gal Tank Subassembly	40	0	1	Ea	25	14

Figure A.9. Gross Requirement Summary

Where-Used Reports

The Single-Level Where-Used report for an item lists each parent in which that item is directly used and in what quantity. For each parent item, the Single-Level Where-Used report lists the following:

- Part number and description for the parent item
- Quantity required
- Item type
- Unit of measure
- Unit cost
- Lead time

The Single-Level Where-Used report for the Clamp is shown in [Figure A.10](#). [Chapter 2](#) describes a macro, `%BOMRSLW`, that constructs a single-level where-used list for a selected item.

Single-Level Where-Used List for Part 0403
Clamp

Final Product	Parent Item	Parent Description	Qty. Required	Type	Unit	Unit Cost	Lead Time
0123	1910	3-Gal Tank Subassembly	1	1	Ea	28	14
0124	4721	4-Gal Tank Subassembly	1	1	Ea	25	14
0125	7350	5-Gal Tank Subassembly	1	1	Ea	25	14

Figure A.10. Single-Level Where-Used Report

The Indented Where-Used report for an item traces its use through the indented bill of material. This report lists the item and steps through each higher-level component or assembly using the item until a final product is reached. At each level, for the current part or assembly, the Indented Where-Used report lists the following:

- Indentation level
- Part number for the parent item
- Part number and description
- Quantity required
- Item type
- Unit of measure
- Unit cost
- Lead time and total lead time
- Final product

The Indented Where-Used report for the Clamp is shown in [Figure A.11](#). [Chapter 2](#) describes a macro, `%BOMRMLW`, that constructs an indented where-used list for a selected item.

Indented Where-Used List for Part 0403
Clamp

Ind. Level	Parent	Part Number	Part Description	Qty. Req.	Type	Unit	Unit Cost	Lead Time	Total Lead Time	Final Product
3	1910	0403	Clamp	1	2	Ea	22	14	49	0123
2	2927	<u>1910</u>	3-Gal Tank Subassembly	1	1	Ea	28	14	35	0123
1	0123	<u>2927</u>	3-Gal Tank Assembly	1	1	Ea	23	14	21	0123
0		0123	3-Gal Carpet Cleaner	.	3	Ea	8	7	7	0123
3	4721	0403	Clamp	1	2	Ea	22	14	49	0124
2	1527	<u>4721</u>	4-Gal Tank Subassembly	1	1	Ea	25	14	35	0124
1	0124	<u>1527</u>	4-Gal Tank Assembly	1	1	Ea	28	14	21	0124
0		0124	4-Gal Carpet Cleaner	.	3	Ea	10	7	7	0124
3	7350	0403	Clamp	1	2	Ea	22	14	49	0125
2	2104	<u>7350</u>	5-Gal Tank Subassembly	1	1	Ea	25	14	35	0125
1	0125	<u>2104</u>	5-Gal Tank Assembly	1	1	Ea	30	14	21	0125
0		0125	5-Gal Carpet Cleaner	.	3	Ea	9	7	7	0125

Figure A.11. Indented Where-Used Report

In addition, the `%BOMRSUW` macro can be used to construct a summarized where-used list for a selected item, which lists the total usage of this item for every higher-level parent using it. See [Chapter 2](#) for more information on these BOM reporting macros.

Shortage and Critical Path Analysis Reports

The BOM Web example includes reports on anticipated part shortages and analyzes the critical path for each planned order. The reports include a rough-cut shortage analysis, critical path identification, and material requirement/availability schedule. These reports are described in the following sections.

Rough-Cut Shortage Analysis Report

The Rough-Cut Shortage Analysis report describes the shortages related to the planned order. This report is termed a “rough-cut” because it does not account for on-hand stock of any items, and assumes that procurement and production begins on the user-specified start date. This report is structured according to the product’s bill of materials, and for the final product and each subassembly or component it lists the following:

- Indentation level
- Part number and description
- Need date (date on which the item is needed)
- Promised date (date on which the item will be available)
- Variance (promised date minus need date; the amount of delay in availability of the item)
- Slack to next assembly (the maximum delay in availability of the item that will not delay availability of the parent item)
- Slack to final product (the maximum delay in availability of the item that will not delay receipt of the final product)
- Lead time and total lead time
- Item type
- Unit of measure
- Part number for the parent item
- Quantity per assembly of the parent item (defining the parent-component relationship)
- Final product’s number
- Quantity needed to produce the amount ordered of the final product

Figure A.12 shows a portion of the Rough-Cut Shortage Analysis report for the order of 40 5-Gal Carpet Cleaners that is due on September 27, 2001. The starting date of the planning period is June 11, 2001. This figure shows only the first eight columns of the report; the remaining columns include Lead Time, Total Lead Time, Type, Unit, Parent, Qty. Per Assembly, Final Product, and Qty. Needed.

Rough-Cut Shortage Analysis

Part: 0125 (5-Gal Carpet Cleaner) Order Quantity: 40
 Start Date: 11JUN2001 Due Date: 27SEP2001

Ind. Level	Part Number	Part Description	Need Date	Promised Date	Variance	Slack to Next Assembly	Slack to Final Product	Lead Time
0	0125	5-Gal Carpet Cleaner	26SEP2001	14OCT2001	18	0	0	
1	1115	Customer Pack	19SEP2001	30SEP2001	11	7	7	
2	1959	Instruct Set	12SEP2001	17JUN2001	-87	98	105	
2	6221-1	Bottled Concentrate	12SEP2001	23SEP2001	11	0	7	1
1	2104	5-Gal Tank Assembly	19SEP2001	07OCT2001	18	0	0	
2	5319	Valve Assembly	05SEP2001	09SEP2001	4	14	14	
2	5746	Hose	05SEP2001	08JUL2001	-59	77	77	
2	7350	5-Gal Tank Subassembly	05SEP2001	23SEP2001	18	0	0	
3	0403	Clamp	22AUG2001	24JUN2001	-59	77	77	
3	1201	

Figure A.12. Rough-Cut Shortage Analysis

Items with positive Variance will not be available in the desired quantity when needed, and hence will have shortage or schedule problems. There might be many items with such problems, but typically only a few affect the release dates for the planned orders.

You can evaluate the impact of the Variance value for an item by comparing it to the two reported slack values. If Variance does not exceed Slack to Next Assembly, availability for the item will not delay production of the listed parent component. If Variance does not exceed Slack to Final Product, availability for the item will not delay release of the order.

The items controlling their parent items' availability are those items with a zero value for Slack to Next Assembly; these are referred to as *pacing items*. Every subassembly has its own pacing item. Items with a zero value for Slack to Final Product are said to be *critical*. For example, Figure A.12 indicates that Part Numbers 0125, 6221-1, 2104, and 7350 are pacing items. In addition, Part Numbers 0125, 2104, and 7350 are critical.

The Rough-Cut Shortage Analysis report uses the CPM procedure to compute the promised date, the slack to next assembly, and the slack to final product, and backward scheduling to determine the need date. You can construct a similar report with

a single call to PROC CPM, followed by one data step. Suppose the indented bill of materials for the 5-Gal Carpet Cleaner is stored in a data set named `IndBOM_0125`. The following code creates a Rough-Cut Shortage Analysis report for the product, which is saved in a data set named `RoughCut0125`. This data set contains the information listed in Figure A.12, along with some additional variables that will be used in the “Material Requirement/Availability Schedule” section on page 149 to produce Gantt charts of the schedules.

```
proc cpm data=IndBOM_0125 out=RoughCut0125
    date='11Jun2001'd addact;
    act Part_ID;
    succ Paren_ID;
    dur Leadtime;
    id _all_;
run;

data RoughCut0125;
    format PromDate NeedDate date9.;
    set RoughCut0125 (rename= (e_finish=PromDate
                             f_float=Slack2NA
                             t_float=Slack2FP));
    NeedDate = '27Sep2001'd - (Tot_Lead-Leadtime) - 1;
    Variance = PromDate - NeedDate;
    QtyNeeded = 40*Qty_Prod;
run;
```

Critical Path Identification Report

The critical items (items with zero Slack to Final Product) in the Rough-Cut Shortage Analysis form a path in the indented bill of material. This path is referred to as the *critical path* for the planned order. The Critical Path Identification Report lists this critical path. Among those critical items are the items that delay product availability; the ones with lowest level are most crucial and often merit special attention and expedited scheduling.

Figure A.13 shows a portion of the Critical Paths report for the order of 40 5-Gal Carpet Cleaners that is due on September 27, 2001. The figure shows only the first nine columns of the report; the remaining columns include Total Lead Time, Type, Unit, Parent, Qty. Per Assembly, Final Product, and Qty. Needed. In this example, steel (Part 5640) is the lowest level item and, therefore, is the most crucial of the critical items.

Critical Paths

Part: 0125 (5-Gal Carpet Cleaner) Order Quantity: 40
 Start Date: 11JUN2001 Due Date: 27SEP2001

Ind. Level	Part Number	Part Description	Need Date	Promised Date	Variance	Slack to Next Assembly	Slack to Final Product	Lead Time
0	0125	5-Gal Carpet Cleaner	26SEP2001	14OCT2001	18	0	0	7
1	2104	5-Gal Tank Assembly	19SEP2001	07OCT2001	18	0	0	14
2	7350	5-Gal Tank Subassembly	05SEP2001	23SEP2001	18	0	0	14
3	5706	5-Gal Painted Tank Bottom	22AUG2001	09SEP2001	18	0	0	21
4	5640	Steel	01AUG2001	19AUG2001	18	0	0	70

Figure A.13. Critical Path Identification Report

Material Requirement/Availability Schedule

The Material Requirement/Availability Schedule is a Gantt chart, a time-scaled graphical depiction of the schedule for a planned order. The schedules for all items needed to fulfill the order are displayed hierarchically, with critical items depicted in red and all others depicted in green schedule bars. Schedule bars indicate the start and finish of production or procurement for each item, and also indicate any slack time that exists. Links between the schedule bars indicate the hierarchical relationships between the items. Milestone markers indicate the Need Date and Promised Date for each item, and a vertical line indicates the Due Date for the order.

The Material Requirement/Availability Schedule for the order of 40 5-Gal Carpet Cleaners is shown in [Figure A.14](#). In this printed version, the red and green schedule bars are indistinguishable; however, the BOM Web example shows a full-color version of the Material Requirement/Availability Schedule, in which the critical items are depicted in red schedule bars, and all other schedule bars are colored green.

In the BOM Web example, the schedule bars are selectable and produce a “Material Requirement Implosion,” which uses a Gantt chart to depict a full level pegging for the selected item. This is a time-scaled Indented Where-Used report for the selected item in the designated final product. [Figure A.15](#) shows the Material Requirement Implosion produced by selecting Steel (Part 5640) from [Figure A.14](#).

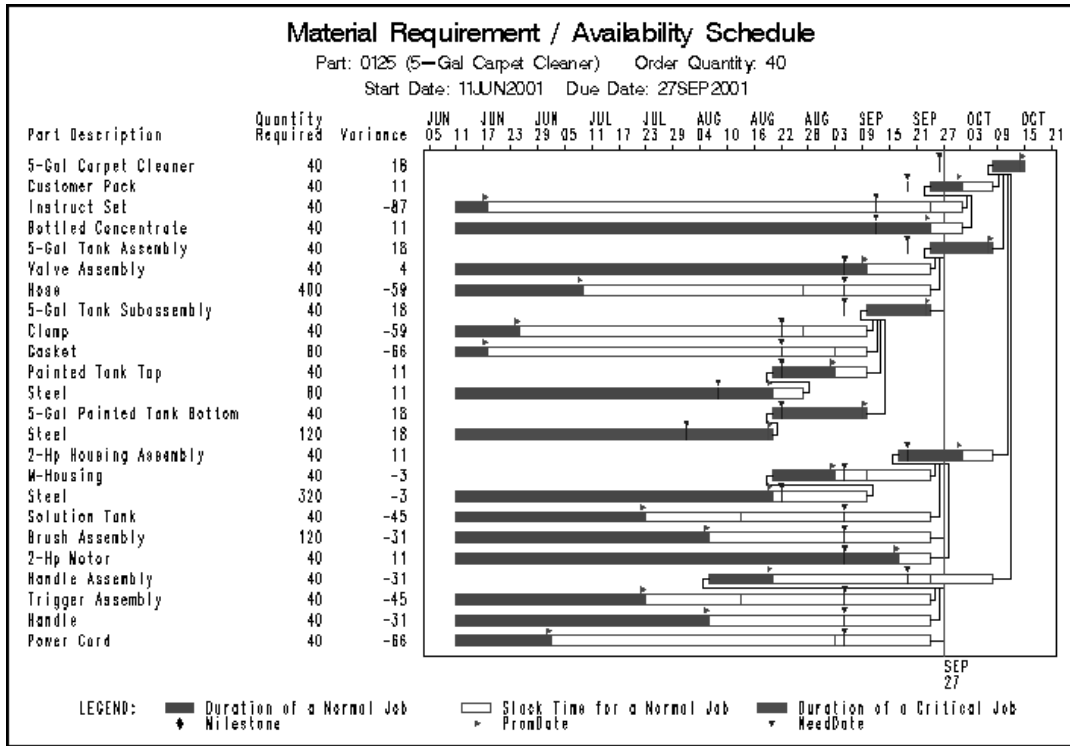

Figure A.14. Material Requirement/Availability Schedule

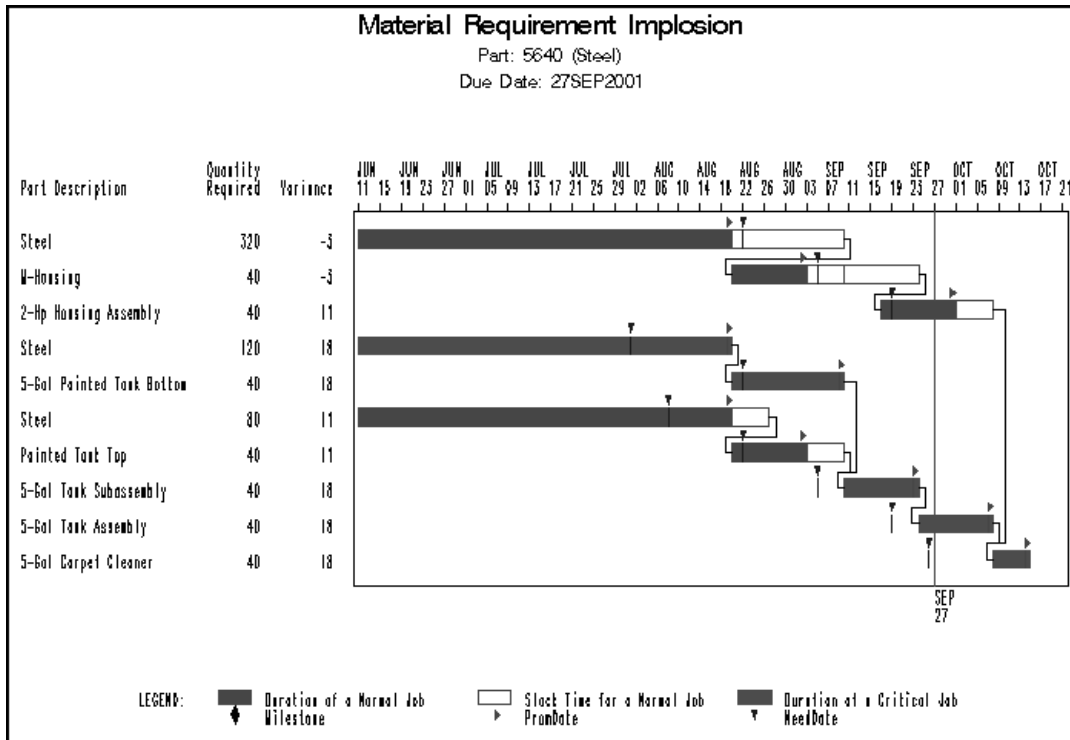

Figure A.15. Material Requirement Implosion

You can use PROC GANTT to produce Material Requirement/Availability Schedules similar to the Gantt chart shown in [Figure A.14](#). The following code produces a Material Requirement/Availability Schedule for the 5-Gal Carpet Cleaner with an order quantity of 40, a starting date of June 11, 2001, and a due date of September 27, 2001. The code uses the RoughCut0125 data set created in the “[Rough-Cut Shortage Analysis Report](#)” section on page 146.

```

title1 'Material Requirement / Availability Schedule';
title2 'Part: 0125 (5-Gal Carpet Cleaner)    Order Quantity: 40';
title3 ' Start Date: 11JUN2001    Due Date: 27SEP2001';

pattern1 v=s c=green;
pattern2 v=e c=green;
pattern3 v=s c=red;
pattern4 v=e c=red;
symbol1  v="B" c=green f=ORFONT h=0.5;
symbol2  v="D" c=blue f=ORFONT h=0.5;

proc gantt data=RoughCut0125
           logic=RoughCut0125;
  chart PromDate NeedDate /
    act=Part_ID
    succ=Paren_ID
    duration=Leadtime
    e_finish=PromDate
    ref='27SEP2001'd
    cref=red
    reflabel
    nojobnum
    noarrowhead
    compress;
  id Description Qty_Prod Variance;
  label Description = 'Part Description'
         Qty_Prod = 'Quantity Required';
run;

```

Subject Index

B

- bill of material (BOM), 17
 - indented, 17, 87, 91, 92
 - modular, 63
 - modularized, 57
 - multilevel, 17
 - planning, 57
 - single-level, 17, 38, 87, 91, 99
 - summarized, 18, 41, 47, 87, 91
 - Web example, 135
- bill of material effectivity dates, 54
- bill of material explosion, 38
 - gross requirements report, 77
 - summarized parts list, 76
- bill of material implosion, 38
 - roll-up cost, 73
- bill of material record,
 - See* indented BOM record
- bill-of-material post-processing macro examples
 - copy-and-paste transaction, 115
 - indented bill of material, 95
 - indented where-used list, 98
 - multiple-delete transaction, 119
 - multiple-replace transaction, 124
 - same-as-except transaction, 130
 - single-level bill of material, 101
 - single-level where-used list, 104
 - summarized bill of material, 107
 - summarized where-used list, 110
- bill-of-material post-processing macros, 40,
 - See also* bill-of-material reporting macros
 - See also* bill-of-material transactional macros
 - _BOMRMLB_ macro variable, 95
 - _BOMRMLW_ macro variable, 98
 - _BOMRSLB_ macro variable, 100
 - _BOMRSLW_ macro variable, 104
 - %BOMRSUB macro, 72, 79
 - _BOMRSUB_ macro variable, 107
 - _BOMRSUW_ macro variable, 110
 - _BOMTCNP_ macro variable, 115
 - _BOMTDEL_ macro variable, 119
 - %BOMTREP macro, 64
 - _BOMTREP_ macro variable, 123
 - %BOMTSAE macro, 64
 - _BOMTSAE_ macro variable, 130
 - input data sets, 88
 - macro variable, 91
 - output data sets, 90
 - overview, 87
 - reporting, 91
 - software requirement, 90
 - transactional, 111
- bill-of-material reporting macros
 - indented bill of material, 92
 - indented where-used list, 96
 - single-level bill of material, 99
 - single-level where-used list, 101
 - summarized bill of material, 104
 - summarized where-used list, 108
- bill-of-material transaction
 - copy-and-paste, 87, 111
 - multiple-delete, 87, 111
 - multiple-replace, 87, 111
 - same-as-except, 87, 111
- bill-of-material transactional macros
 - copy-and-paste transaction, 111
 - multiple-delete transaction, 118
 - multiple-replace transaction, 121
 - same-as-except transaction, 126
- BOM examples
 - aggregating forecasts, 79
 - bill of material explosion, 76
 - bills of material verification, 70
 - bills of material with repeated relationships, 66
 - modular bills of material, 63
 - planning bill of material, 57
 - roll-up cost, 73
 - Web example, 135
 - with lead time information, 48
 - with scrap factor information, 54
 - with single input data set, 44
- BOM procedure
 - computer resource requirements, 25, 26, 44
 - functional summary, 24
 - Indented BOM data set, 26
 - input data sets, 30, 32
 - missing values, 42
 - options classified by function, 24
 - _ORBOM_ macro variable, 43
 - output data sets, 34, 40
 - overview, 17
 - Part Master data set, 26
 - Product Structure data set, 25
 - Summarized Parts data set, 26
 - table of syntax elements, 24
 - variables, 31, 32

%BOMRMLB macro
 input data sets, 94
 output data sets, 95
 BOMRMLB macro variable, 95
 %BOMRMLW macro
 input data sets, 97
 output data sets, 98
 BOMRMLW macro variable, 98
 %BOMRSLB macro
 input data sets, 100
 output data sets, 100
 BOMRSLB macro variable, 100
 %BOMRSLW macro
 input data sets, 103
 output data sets, 103
 BOMRSLW macro variable, 104
 %BOMRSUB macro
 input data sets, 106
 output data sets, 106
 BOMRSUB macro variable, 107
 %BOMRSUW macro
 input data sets, 109
 output data sets, 110
 BOMRSUW macro variable, 110
 %BOMTCNP macro
 input data sets, 113
 output data sets, 115
 BOMTCNP macro variable, 115
 %BOMTDEL macro
 input data sets, 118
 output data sets, 118
 BOMTDEL macro variable, 119
 %BOMTREP macro
 input data sets, 123
 output data sets, 123
 BOMTREP macro variable, 123
 %BOMTSAE macro
 input data sets, 128
 output data sets, 129
 BOMTSAE macro variable, 130

C

Component variable
 Indented BOM data set, 93, 96, 100, 102, 105, 108

Component variables
 Product Structure data set, 27, 32

computer resource requirements
 BOM procedure, 25, 26, 44

copy-and-paste transaction, 87, 111

CPU requirement,
 See computer resource requirements

D

data sets,
 See SAS data sets

data storage requirements,
 See computer resource requirements

dependent demand process, 31, 41, 43

E

effectivity dates,
 See bill of material effectivity dates
 end item, 27
 errors
 BOM procedure, 42, 43
 examples,
 See BOM examples
 See bill-of-material post-processing macro examples
 statement and option cross-reference tables (PROC BOM), 83

F

Factor variables
 Indented BOM data set, 35, 37
 Product Structure data set, 27
 functional summary
 BOM procedure, 24

G

Gros_Req variable
 Summarized Parts data set, 22, 40
 gross requirements report, 77,
 See also summarized parts list

I

ID variables
 Indented BOM data set, 28, 35, 37
 Part Master data set, 27, 31
 Product Structure data set, 32
 Summarized Parts data set, 28, 40, 41
 indented bill of material, 87, 91, 92
 indented bills of material, 17, 18, 27,
 See also Indented BOM data set
 Indented BOM data set, 18, 20, 21, 26, 88
 variables, 34, 37
 indented BOM record, 34
 indented where-used list, 38, 87, 92, 96
 independent demand, 31
 input data sets,
 See also Product Structure data set
 See also Part Master data set
 bill-of-material post-processing macros, 88
 BOM procedure, 30, 32
 %BOMRMLB macro, 94
 %BOMRMLW macro, 97
 %BOMRSLB macro, 100
 %BOMRSLW macro, 103
 %BOMRSUB macro, 106
 %BOMRSUW macro, 109
 %BOMTCNP macro, 113
 %BOMTDEL macro, 118
 %BOMTREP macro, 123
 %BOMTSAE macro, 128
 item master record,
 See part master record

L

lead time, 28
 lead-time offset, 28, 32
 LeadTime variable
 Indented BOM data set, 35, 37
 Part Master data set, 28, 31
 Product Structure data set, 32
 Summarized Parts data set, 40, 41
 Level variable
 Indented BOM data set, 21, 35, 37, 38
 line sequence number, 66
 L_Offset variable
 Indented BOM data set, 35
 low-level code, 22, 40
 Low_Code variable
 Summarized Parts data set, 22, 40, 41

M

macro variable
 bill-of-material post-processing macros, 91
 BOMRMLB, 95
 BOMRMLW, 98
 BOMRSLB, 100
 BOMRSLW, 104
 BOMRSUB, 107
 BOMRSUW, 110
 BOMTCNP, 115
 BOMTDEL, 119
 BOMTREP, 123
 BOMTSAE, 130
 ORBOM, 43
 master production plan,
 See production plan
 master schedule item, 31, 40
 memory requirements,
 See computer resource requirements
 missing values
 BOM procedure, 42
 model item, 57
 modular bills of material, 63
 modularized bill of material construction, 57
 multilevel bill of material, 17
 multiple-delete transaction, 87, 111, 118
 multiple-replace transaction, 87, 111, 121

N

Net_Req variable
 Summarized Parts data set, 22, 40, 41

O

Offset variables
 Indented BOM data set, 35, 37
 Product Structure data set, 28
 On_Hand variable,
 See also QtyOnHand variable
 Product Structure data set, 29
 Summarized Parts data set, 22, 40
 option overplanning, 59
 options classified by function,

See functional summary
 ORBOM macro variable, 43
 output data sets,
 See also Indented BOM data set
 See also Summarized Parts data set
 bill-of-material post-processing macros, 90
 BOM procedure, 34, 40
 %BOMRMLB macro, 95
 %BOMRMLW macro, 98
 %BOMRSLB macro, 100
 %BOMRSLW macro, 103
 %BOMRSUB macro, 106
 %BOMRSUW macro, 110
 %BOMTCNP macro, 115
 %BOMTDEL macro, 118
 %BOMTREP macro, 123
 %BOMTSAE macro, 129
 overview
 bill-of-material post-processing macros, 87
 BOM procedure, 17

P

Paren_ID variable
 Indented BOM data set, 21, 35, 37
 parent record, 21, 34, 38
 Parent variable
 Product Structure data set, 28
 parent-component relationship, 18,
 See also product structure record
 Parent variable
 Indented BOM data set, 20, 34, 37
 Part Master data set, 18, 26, 88
 missing values, 42
 variables, 31
 part master file,
 See Part Master data set
 part master record, 17, 30
 Part variable
 Part Master data set, 29, 31
 Product Structure data set, 32
 Part variable
 Indented BOM data set, 20, 34, 37
 Summarized Parts data set, 40, 41
 Part_ID variable
 Indented BOM data set, 20, 21, 35, 37
 phantom bill of material,
 See planning bill of material
 phantom item, 57
 planning bill of material, 57
 post-processing macros,
 See bill-of-material post-processing macros
 problem size specification
 BOM procedure, 44
 number of items (BOM), 25
 number of product structure records (BOM), 26
 utility data sets (BOM), 25
 Prod variable
 Indented BOM data set, 21, 37
 Product Structure data set, 18, 25, 88

- identical product structure records, 25
 - missing values, 42
 - variables, 32
- product structure file,
 - See* Product Structure data set
- product structure record, 17
- production plan, 17
- pseudo bill of material,
 - See* planning bill of material

Q

- QtyOnHand variable
 - Part Master data set, 31
 - Product Structure data set, 29, 32
 - Summarized Parts data set, 29, 40, 41
- Qty_Per variable
 - Indented BOM data set, 34
- QtyPer variables,
 - See* Quantity variables
- Qty_Prod variable
 - Indented BOM data set, 21, 35, 37
- quantity per assembly, 29, 32
- quantity per product, 21, 36, 55
- Quantity variables
 - Indented BOM data set, 34, 37
 - Product Structure data set, 29, 32

R

- record
 - parent, 21, 34, 38
 - part master, 17
 - product structure, 17
 - root, 34
- Requirement variable
 - Part Master data set, 29, 31
 - Product Structure data set, 32
 - Summarized Parts data set, 40, 41
- RID variables
 - Indented BOM data set, 30, 35, 37
 - Product Structure data set, 30
- root record, 34

S

- same-as-except transaction, 87, 111, 126
- SAS data sets,
 - See also* input data sets
 - See also* output data sets
 - %BOMRMLB macro, 94, 95
 - %BOMRMLW macro, 97, 98
 - %BOMRSLB macro, 100
 - %BOMRSLW macro, 103
 - %BOMRSUB macro, 106
 - %BOMRSUW macro, 109, 110
 - %BOMTCNP macro, 113, 115
 - %BOMTDEL macro, 118
 - %BOMTREP macro, 123
 - %BOMTSAE macro, 128, 129
 - bill-of-material post-processing macros, 88, 90
 - BOM procedure, 30, 32, 34, 40

- SAS macros,
 - See also* bill-of-material post-processing macros
 - See* bill-of-material post-processing macros
- scrap factor, 27, 32, 54
- S_Factor variable
 - Indented BOM data set, 35
- single-level bill of material, 17, 38, 87, 91, 99
- Single-level BOM data set,
 - See* Product Structure data set
- single-level where-used list, 38, 87, 92, 101
- summarized bill of material, 18, 41, 47, 73, 87, 91, 104,
 - See also* summarized parts list
- Summarized Parts data set, 18, 26
 - variables, 40, 41
- summarized parts list, 17, 40, 76,
 - See also* Summarized Parts data set
- summarized where-used list, 87, 92, 108
- super bill of material,
 - See* planning bill of material
- syntax skeleton
 - BOM procedure, 24

T

- table of syntax elements,
 - See* functional summary
- Tot_Lead variable
 - Indented BOM data set, 28, 36, 37
- Tot_Off variable
 - Indented BOM data set, 28, 36, 37

V

- variables
 - list of, BOM procedure, 31, 32, 37, 41
 - treatment of missing values (BOM), 42

W

- Web example, 135
- where-used list
 - indented, 38, 87, 92, 96
 - single-level, 38, 87, 92, 101
 - summarized, 87, 92, 108

Syntax Index

B

BOM procedure, 24
 PROC BOM statement, 25
 STRUCTURE statement, 26
%BOMRMLB macro, 92
%BOMRMLW macro, 96
%BOMRSLB macro, 99
%BOMRSLW macro, 101
%BOMRSUB macro, 104
%BOMRSUW macro, 108
%BOMTCNP macro, 111
%BOMTDEL macro, 118
%BOMTREP macro, 121
%BOMTSAE macro, 126

C

COMBINE keyword
 DUPLICATE= option, 25
COMP= option,
 See COMPONENT= option
COMPONENT= option
 STRUCTURE statement, 27

D

DATA= option
 PROC BOM statement, 25
DISCARD keyword
 DUPLICATE= option, 25
DUPLICATE= option
 PROC BOM statement, 25
DUR= option,
 See LEADTIME= option

E

ENDITEM= option
 STRUCTURE statement, 27

F

FACTOR= option
 STRUCTURE statement, 27

G

GROSSREQ= option,
 See REQUIREMENT= option

I

ID= option
 STRUCTURE statement, 27

INDBOM= option,
 See OUT= option
INVENTORY= option,
 See QTYONHAND= option
ITEM= option,
 See PART= option

K

KEEP keyword
 DUPLICATE= option, 25

L

LEADTIME= option
 STRUCTURE statement, 28
LTOFFSET= option,
 See OFFSET= option

N

NOUTIL option
 PROC BOM statement, 25
NPARTS= option
 PROC BOM statement, 25
NRELATIONSHIPS= option,
 See NRELTS= option
NRELTS= option
 PROC BOM statement, 26

O

OFFSET= option
 STRUCTURE statement, 28
ORBOM, 1
OUT= option
 PROC BOM statement, 26

P

PARENT= option
 STRUCTURE statement, 28
PART= option
 STRUCTURE statement, 29
PMASTER= option
 See PMDATA= option, 26
PMDATA= option
 PROC BOM statement, 26
PROC BOM statement,
 See also BOM procedure
 statement options, 25
PSDATA= option,
 See DATA= option

Q

QTYONHAND= option
 STRUCTURE statement, 29
QTYPER= option,
 See QUANTITY= option
QUANTITY= option
 STRUCTURE statement, 29

R

REQUIREMENT= option
 STRUCTURE statement, 29
RID= option
 STRUCTURE statement, 30

S

SAS/ORBOM, 1
SFACTOR= option,
 See FACTOR= option
STRUCTURE statement
 BOM procedure, 26
SUMMARYOUT= option
 PROC BOM statement, 26
SUMPART= option,
 See SUMMARYOUT= option

Your Turn

If you have comments or suggestions about *SAS/OR® 9.1 User's Guide: Bills of Material Processing*, please send them to us on a photocopy of this page or send us electronic mail.

For comments about this book, please return the photocopy to

SAS Publishing
SAS Campus Drive
Cary, NC 27513
E-mail: yourturn@sas.com

For suggestions about the software, please return the photocopy to

SAS Institute Inc.
Technical Support Division
SAS Campus Drive
Cary, NC 27513
E-mail: suggest@sas.com

